

Automotive







Automotive

Automotive

A comprehensive range of the world's best brands, suitable for the most demanding professional.

All products carry our full lifetime warranty and selected tools meet the standards of international tests and regulations.

				
Spanners 94-107	Sockets & Accessories 108-135	Socket Sets 136-155	Tool Kits 156-162	Testing Tools 163-171
				
Lubrication 172-179	Pullers & Compressors 180-185	Bottle & Scissor Jacks 186	Trolley Jacks 186-188	Transmission Jacks 188-189
				
Truck, Forklift & Pallet Jacks 190-191	Trestles & Chocks 191-192	Pullers & Winches 193	Hydraulic Pumps 194-196	Hoists 197
				
Cranes 198	Presses 199	Battery Chargers & Jump Leads 200-202	Workshop Tools & Accessories 203-208	Bodyshop Tools 209



SUPER DRIVE COMBINATION SPANNERS

Super-Drive
One socket/spanner for every type of bolt!

- Super drive spanners are the only tool you need for all varieties of bolts
- Round is not the perfect shape, six sided and wedge shaped sockets will damage bolts and nuts when transferring high forces
- Super drive spanners have a unique profile which enables the use of spanners on metric, SAE, Torx®, spline and square shaped bolts and nuts
- Chrome vanadium steel, correctly hardened and tempered for maximum strength and durability
- Satin chrome plated for corrosion protection



One spanner for every type of bolt!



Code	Metric	Imperial	E. Nut	Ref.
RIC7790	6mm	1/4"	E8	25506H
RIC7791	7mm	9/32"	E9	25507H
RIC7792	8mm	5/16"	E10	25508H
RIC7793	9mm	11/32"	E11	25509H
RIC7794	10mm	3/8"	E12	25510H
RIC7795	11mm	7/16"	E14	25511H
RIC7796	12mm	15/32"	E14	25512H
RIC7797	13mm	1/2"	E16	25513H
RIC7798	14mm	9/16"	E18	25514H
RIC7799	15mm	19/32"	E18	25515H
RIC7800	16mm	5/8"	E20	25516H
RIC7801	17mm	21/32"	E20	25517H
RIC7802	18mm	11/16"	E22	25518H

Code	Metric	Imperial	E. Nut	Ref.
RIC7803	19mm	3/4"	E24	25519H
RIC7804	20mm	25/32"	E25	25520H
RIC7805	21mm	13/16"	E26	25521H
RIC7806	22mm	7/8"	E28	25522H
RIC7807	23mm	29/32"	E28	25523H
RIC7808	24mm	15/16"	E30	25524H
RIC7809	25mm	31/32"	E32	25525H
RIC7810	26mm	1"	E32	25526H
RIC7811	27mm	1 1/16"	E34	25527H
RIC7812	28mm	1 3/32"	E36	25528H
RIC7813	29mm	1 1/8"	E36	25529H
RIC7814	30mm	1 3/16"	E38	25530H
RIC7815	32mm	1 1/4"	E40	25532H

DIN 3122

DIN 3123

DIN 3124



DEEP OFFSET COMBINATION SPANNERS

- Professional quality, drop forged from chrome-vanadium steel
- Controlled heat treatment and tempering
- Precision machining and broaching
- Professional weight and balance
- Flat long handles with rounded edge satin-chrome plated with polished ends
- Open ends at 15° angle for working in confined areas and box ends have 45° angle offset for clearance over obstructions.



DIN 3113



Code	Size	Ref.
RIC3606	6mm	25571C
RIC3607	7mm	25572C
RIC3608	8mm	25573C
RIC3609	9mm	25574C
RIC3610	10mm	25575C
RIC3611	11mm	25576C
RIC3612	12mm	25577C
RIC3613	13mm	25578C
RIC3614	14mm	25579C
RIC3615	15mm	25580C
RIC3616	16mm	25581C

Code	Size	Ref.
RIC3617	17mm	25582C
RIC3618	18mm	25583C
RIC3619	19mm	25584C
RIC3620	20mm	25585C
RIC3621	21mm	25586C
RIC3622	22mm	25587C
RIC3623	23mm	25588C
RIC3624	24mm	25589C
RIC3625	25mm	25590C
RIC3626	26mm	25591C
RIC3627	27mm	25592C

Code	Size	Ref.
RIC3628	28mm	25593C
RIC3629	29mm	227
RIC3630	30mm	25595
RIC3632	32mm	25597
RIC3633	33mm	227
RIC3634	34mm	227
RIC3636	36mm	227
RIC3641	41mm	227
RIC3642	46mm	227
RIC3643	50mm	227

Automotive



COMBINATION SPANNER - OPEN BOX - 13

- AS-DRIVE
- DIN 3113 form A / ISO 7738 form A (metric sizes)
- Chrome Alloy Steel
- Chrome plated



COMBINATION SPANNER OPEN BOX - 16



*Specifications as above

Part No.	Size
STW40095050	5mm

Part No.	Size	Part No.	Size	Part No.	Size	Part No.	Size
STW40085500	5.5mm	STW40081313	13mm	STW40082121	21mm	STW40083434	34mm
STW40080606	6mm	STW40081414	14mm	STW40082323	23mm	STW40083636	36mm
STW40080707	7mm	STW40081515	15mm	STW40082424	24mm	STW40083838	38mm
STW40080808	8mm	STW40081616	16mm	STW40082525	25mm	STW40084141	41mm
STW40080909	9mm	STW40081717	17mm	STW40082626	26mm	STW40084646	46mm
STW40081010	10mm	STW40081818	18mm	STW40082727	27mm	STW40085050	50mm
STW40081111	11mm	STW40081919	19mm	STW40082828	28mm	STW40085555	55mm
STW40081212	12mm	STW40082020	20mm	STW40083030	30mm	STW40086060	60mm
				STW40083232	32mm		



SPANNER - COMBINATION OPEN BOX - 13A

- AS-DRIVE
- DIN 3113 form A / ISO 7738 form A (metric sizes)
- Chrome Alloy Steel
- Chrome plated



Part No.	Size	Part No.	Size	Part No.	Size	Part No.	Size
STW40481212	3/16"	STE40482828	7/16"	STW40484242	13/16"	STW40485858	1 5/16"
STW40481414	7/32"	STW40483232	1/2"	STW40484444	7/8"	STW40486060	1 3/8"
STW40481616	1/4"	STW40483434	9/16"	STW40484646	15/16"	STW40486262	1 7/16"
STW40481818	9/32"	STW40483535	19/32"	STW40484848	1"	STW40486464	1 1/2"
STW40482020	5/16"	STW40483636	5/8"	STW40485050	1 1/16"	STW40486666	1 5/8"
STW40482222	11/32"	STW40483838	11/16"	STW40485252	1 1/8"	STW40487070	1 7/8"
STW40482424	3/8"	STW40484040	3/4"	STW40485656	1 1/4"	STW40487272	2"



COMBINATION SPANNERS - 1B

- CHROME VANADIUM Steel - CrV3
- Chrome Plated, polished rings
- Rings - thin walled with deep offset
- UD profile
- Same size each end



Part No.	Size	Part No.	Size	Part No.	Size	Part No.	Size
GED600040	6mm	GED600156	16mm	GED600253	26mm	GED600512	1/4"
GED600059	7mm	GED600164	17mm	GED600261	27mm	GED600628	13/16"
GED600067	8mm	GED600172	18mm	GED600288	28mm	GED600636	7/8"
GED600075	9mm	GED600180	19mm	GED600296	29mm	GED600644	15/16"
GED600083	10mm	GED600199	20mm	GED600318	30mm	GED600652	1"
GED600091	11mm	GED600202	21mm	GED600326	32mm	GED600660	1 1/16"
GED600105	12mm	GED600210	22mm	GED600415	34mm	GED600679	1 1/8"
GED600113	13mm	GED600229	23mm	GED600342	36mm	GED600687	1 1/4"
GED600121	14mm	GED600237	24mm	GED002527	41mm	GED600695	1 5/16"
GED600148	15mm	GED600245	25mm	GED002528	46mm	GED600709	1 3/8"
				GED002529	50mm	GED600725	1 1/2"-38mm



COMBINATION SPANNERS - 7

- CHROME VANADIUM steel - 31CrV3
- Chrome plated
- Polished rings
- Rings - thin walled with slight offset
- UD profile
- Same size on both ends



Part No.	Size	Part No.	Size	Part No.	Size	Part No.	Size
GED608955	6mm	GED609021	12mm	GED609188	18mm	GED609234	25mm
GED608963	7mm	GED609048	13mm	GED609080	19mm	GED609242	26mm
GED908971	8mm	GED609056	14mm	GED609196	20mm	GED609110	27mm
GED608998	9mm	GED609064	15mm	GED609218	21mm	GED609250	28mm
GED609005	10mm	GED609161	16mm	GED609099	22mm	GED609269	29mm
GED609013	11mm	GED609072	17mm	GED609226	23mm	GED609129	30mm
				GED609102	24mm	GED609137	32mm



DEEP OFFSET COMBINATION SPANNER - SETS

- Professional quality, drop forged from chrome-vanadium steel
- Controlled heat treatment and tempering
- Precision machining and broaching
- Professional weight and balance
- Flat long handles with rounded edge satin-chrome plated with polished ends
- Open ends at 15° angle for working in confined areas and box ends have 45° angle offset for clearance over obstructions



DIN 3113



SPANNER - COMBINATION SET 6 PC

- Contents: 10, 12, 13, 14, 17, 19mm
- Supplied in vinyl storage pouch

Part No.	Size
RIC3644	6 pce

SPANNER - COMBINATION SET 17 PC

- Contents: 6, 7, 8, 9, 10, 11, 12, 13, 14, 15, 16, 17, 18, 19, 20, 21, 22mm
- Supplied in vinyl storage pouch

Part No.	Size
RIC3651	17 pce

SPANNER - COMBINATION SET 8 PC

- Contents: 10, 12, 13, 14, 17, 19, 22, 24mm
- Supplied in vinyl storage pouch

Part No.	Size
RIC3646	8 pce

SPANNER - COMBINATION SET 18 PC

- Contents: 6, 7, 8, 9, 10, 11, 12, 13, 14, 15, 16, 17, 18, 19, 20, 21, 22, 24mm
- Supplied in vinyl storage pouch

Part No.	Size
RIC3647	18 pce

SPANNER - COMBINATION SET 12 PC

- Contents 10, 11, 12, 13, 14, 17, 19, 22, 24, 27, 30, 32mm
- Supplied in vinyl storage pouch

Part No.	Size
RIC3648	12 pce

SPANNER - COMBINATION SET 26 PC

- Contents: 6, 7, 8, 9, 10, 11, 12, 13, 14, 15, 16, 17, 18, 19, 20, 21, 22, 23, 24, 25, 26, 27, 28, 29, 30, 32mm
- Supplied in vinyl storage pouch

Part No.	Size
RIC3653	26 pce



COMBINATION SPANNER SET

- Chrome vanadium steel
- Attractive display hanger doubles up as a clever case and handle
- Contents: 6, 8, 10, 12, 13, 14, 15, 17, 19mm



Part No.	Size
MTS4584	9 pce



COMBINATION SPANNER SET 10 13/10KT

- AS-DRIVE
- DIN 3113 form A/ISO 7738 form A (metric sizes)
- Chrome Alloy Steel
- Chrome plated
- Contents: No.13: 8, 9, 10, 11, 12, 13, 14, 15, 17, 19mm



Part No.	Size
STW96400808	10 pce



COMBINATION SPANNER SET 26 PIECE - 13/26

- AS-Drive
- DIN 3113 form A / ISO 7738 form A (metric sizes)
- Chrome Alloy Steel
- Chrome plated
- Contents: No.13: 6, 7, 8, 9, 10, 11, 12, 13, 14, 15, 16, 17, 18, 19, 20, 21, 22, 23, 24, 25, 26, 27, 28, 29, 30, 32mm



Part No.	Size
STW96400805	26 pce



COMBINATION SPANNER SET - IMPERIAL 10 PIECE - 13A10KT

- AS-Drive
- DIN 3113 form A / ISO 7738 form A (metric sizes)
- Chrome Alloy Steel
- Chrome plated
- Contents: 13A: 1/4", 5/16", 11/32", 3/8", 7/16", 1/2", 9/16", 5/8", 11/16", 3/4"



Part No.	Size
STW96404812	10 pce



COMBINATION SPANNER SET - IMPERIAL 20 PIECE - 13A/20

- AS-Drive
- DIN 3113 form A / ISO 7738 form A (metric sizes)
- Chrome Alloy Steel
- Chrome plated
- Contents: 13A: 1/4", 9/32", 5/16", 11/32", 3/8", 7/16", 1/2", 9/16", 19/32", 5/8", 11/16", 3/4", 25/32", 13/16", 7/8", 15/16", 1", 1-1/16", 1-1/8", 1-1/4"



Part No.	Size
STW96404804	20 pce



COMBINATION SPANNER - 6 PIECE SET 1B/06M

- CHROME VANADIUM Steel - CrV3
- Chrome Plated, polished rings
- Rings - thin walled with deep offset
- UD profile
- Same size each end
- Contents: 10, 11, 13, 14, 17, 19mm
- Supplied in box



Part No.
GED601160



COMBINATION SPANNER - 13 PIECE SET 1B/13A

- CHROME VANADIUM Steel - CrV3
- Chrome Plated, polished rings
- Rings - thin walled with deep offset
- UD profile
- Same size each end
- Contents: 1/4", 5/16", 3/8", 7/16", 1/2", 9/16", 5/8", 11/16", 3/4", 13/16", 7/8", 15/16", 1"
- Supplied in box



Part No.
GED601179



COMBINATION SPANNER - 8 PIECE SET 1B/08M

- CHROME VANADIUM Steel - CrV3
- Chrome Plated, polished rings
- Rings - thin walled with deep offset
- UD profile
- Same size each end
- Contents: 10, 12, 13, 14, 17, 19, 22, 24mm
- Supplied in box



Part No.
GED601187



COMBINATION SPANNER - 17 PIECE SET 1B/017A

- CHROME VANADIUM Steel - CrV3
- Chrome Plated, polished rings
- Rings - thin walled with deep offset
- UD profile
- Same size each end
- Contents: 1/4", 5/16", 3/8", 7/16", 1/2", 9/16", 5/8", 11/16", 3/4", 13/16", 7/8", 15/16", 1", 1-1/16", 1-1/8, 1-3/16", 1-1/4"
- Supplied in box



Part No.
GED601209



COMBINATION SPANNER - 12 PIECE SET 1B/012M

- CHROME VANADIUM Steel - CrV3
- Chrome Plated, polished rings
- Rings - thin walled with deep offset
- UD profile
- Same size each end
- Contents: 10, 11, 12, 13, 14, 17, 19, 22, 24, 27, 30, 32mm
- Supplied in box



Part No.
GED601217

Automotive

GEDORE Tools For Life **COMBINATION SPANNER - 17 PIECE SET 1B/17M**

- CHROME VANADIUM Steel - CrV3
- Chrome Plated, polished rings
- Rings - thin walled with deep offset
- UD profile
- Same size each end
- Contents: 6, 7, 8, 9, 10, 11, 12, 13, 14, 15, 16, 17, 18, 19, 20, 21, 22mm
- Box



Part No.
GED601268

GEDORE Tools For Life **COMBINATION SPANNER - 26 PIECE SET 1B/26M**

- CHROME VANADIUM Steel - CrV3
- Chrome Plated, polished rings
- Rings - thin walled with deep offset
- UD profile
- Same size each end
- Contents: 6, 7, 8, 9, 10, 11, 12, 13, 14, 15, 16, 17, 18, 19, 20, 21, 22, 23, 24, 25, 26, 27, 28, 29, 30, 32mm
- Box



Part No.
GED601276

GEDORE Tools For Life **COMBINATION SPANNER - 18 PIECE SET 1B/18M**

- CHROME VANADIUM Steel - CrV3
- Chrome Plated, polished rings
- Rings - thin walled with deep offset
- UD profile
- Same size each end
- Contents: 6, 7, 8, 9, 10, 11, 12, 13, 14, 15, 16, 17, 18, 19, 20, 21, 22, 24mm
- Supplied in box



Part No.
GED601438

GEDORE Tools For Life **COMBINATION SPANNER - 17 PIECE SET 7/17M**

- CHROME VANADIUM steel - 31CrV3
- Chrome plated
- Polished rings
- Rings - thin walled with slight offset
- UD profile
- Same size on both ends
- Contents: 6, 7, 8, 9, 10, 11, 12, 13, 14, 15, 16, 17, 18, 19, 20, 21, 22mm



Part No.
GED609358

GEDORE Tools For Life **COMBINATION SPANNER - 26 PIECE SET 7/26M**

- CHROME VANADIUM steel - 31CrV3
- Chrome plated with polished rings
- Rings - thin walled with slight offset
- UD profile
- Same size on both ends
- Contents: 6, 7, 8, 9, 10, 11, 12, 13, 14, 15, 16, 17, 18, 19, 20, 21, 22, 23, 24, 25, 26, 27, 28, 29, 30, 32mm



Part No.
GED609374

GEDORE Tools For Life **COMBINATION SPANNER - 4 PIECE SET 1B/04M**

- CHROME VANADIUM Steel - CrV3
- Chrome Plated, polished rings
- Rings - thin walled with deep offset
- UD profile
- Same size each end
- Contents: 10, 13, 17, 19mm
- In blister pack



Part No.
GED601152

STAHLWILLE **SPANNER - DOUBLE OPEN ENDED - 10A**

- DIN 3110, ISO 10102 (metric sizes)
- Chrome Alloy Steel
- Chrome plated



Part No.	Size
STW40431620	1/4" x 5/16"
STW40432024	5/16" x 3/8"
STW40432428	3/8" x 7/16"
STW40432832	7/16" x 1/2"
STW40433234	1/2" x 9/16"

Part No.	Size
STW40433436	9/16" x 5/8"
STW40433638	5/8" x 11/16"
STW40433640	5/8" x 3/4"
STW40434044	3/4" x 7/8"
STW40434142	25/32" x 13/16"

DOUBLE OPEN ENDED SPANNER - 6

- CHROME VANADIUM steel - 31CrV3
- Chrome plated
- Polished shoulders
- Slim pattern
- Oval shaft



Part No.	Size	Part No.	Size	Part No.	Size	Part No.	Size
GED606383	6 x 7mm	GED606588	14 x 15mm	GED606685	20 x 22mm	GED606804	27 x 32mm
GED606421	8 x 9mm	GED606626	16 x 17mm	GED606707	21 x 23mm	GED606812	30 x 32mm
GED606448	8 x 10mm	GED606642	17 x 19mm	GED606731	24 x 26mm	GED606839	32 x 36mm
GED606472	10 x 11mm	GED606650	18 x 19mm	GED606758	24 x 27mm	GED004521	36 x 41mm
GED606537	12 x 13mm	GED606677	19 x 22mm	GED606774	25 x 28mm	GED004523	41 x 46mm

**DOUBLE OPEN ENDED SPANNER
4 PIECE SET - 6/04M**

- CHROME VANADIUM steel - 31CrV3
- Chrome plated
- Polished shoulders
- Slim pattern
- Oval shaft
- Contents: 10 x 11, 12 x 13, 14 x 15, 16 x 17mm
- In blister pack



Part No.
GED607703

**DOUBLE OPEN ENDED SPANNER
8 PIECE SET - 6/8M**

- CHROME VANADIUM steel - 31CrV3
- Chrome plated
- Polished shoulders
- Slim pattern
- Oval shaft
- Contents: 6 x 7, 8 x 9, 10 x 11, 12 x 13, 14 x 15, 16 x 17, 18 x 19, 20 x 22mm



Part No.
GED607738

**DOUBLE OPEN ENDED SPANNER
10 PIECE SET - 6/10M**

- CHROME VANADIUM steel - 31CrV3
- Chrome plated
- Polished shoulders
- Slim pattern
- Oval shaft
- Contents: 6 x 7, 8 x 9, 10 x 11, 12 x 13, 14 x 15, 16 x 17, 18 x 19, 20 x 22, 21 x 23, 24 x 27mm



Part No.
GED607754

**DOUBLE OPEN ENDED SPANNER
12 PIECE SET - 6/12M**

- CHROME VANADIUM steel - 31CrV3
- Chrome plated
- Polished shoulders
- Slim pattern
- Oval shaft
- Contents: 6 x 7, 8 x 9, 10 x 11, 12 x 13, 14 x 15, 16 x 17, 18 x 19, 20 x 22, 21 x 23, 24 x 26, 25 x 28, 27 x 32mm



Part No.
GED607770

SPANNER - SINGLE ENDED - 4004

- DIN 894
- Special tool steel
- Grey finish



Part No.	Size	Part No.	Size
STW40040240	24mm	STW40040550	55mm
STW40040360	36mm	STW40040600	60mm
STW40040410	41mm	STW40040665	65mm
STW40040460	46mm	STW40040700	70mm
STW40040500	50mm	STW40040750	75mm

**SPANNER - DOUBLE ENDED
RING - STARTER - 27**

- AS-Drive
- ISO 3318
- Chrome Alloy Steel
- Chrome plated



Part No.	Size
STW41091012	10 x 12mm
STW41091113	11 x 13mm
STW41091416	14 x 16mm
STW41091417	14 x 17mm
STW41091517	15 x 17mm
STW41091922	19 x 22mm

Automotive



GEDORE RING SPANNER - DOUBLE ENDED - 2

- CHROME VANADIUM steel - 31CrV3
- Chrome Plated, polished rings
- Rings - thin walled with deep offset
- UD profile



Part No.	Size	Part No.	Size	Part No.	Size
GED601535	6 x 7mm	GED601748	17 x 19mm	GED601853	24 x 30mm
GED601551	8 x 9mm	GED601756	18 x 19mm	GED601861	25 x 28mm
GED601594	10 x 11mm	GED601780	20 x 22mm	GED601918	27 x 32mm
GED601659	12 x 13mm	GED601799	19 x 24mm	GED601926	30 x 32mm
GED601691	14 x 15mm	GED601802	21 x 23mm	GED601934	30 x 36mm
GED601721	16 x 17mm	GED601837	24 x 26mm	GED601942	32 x 36mm

GEDORE RING SPANNER DOUBLE ENDED SET 2/12M

- CHROME VANADIUM steel - 31CrV3
- Chrome Plated, polished rings
- Rings - thin walled with deep offset
- UD profile
- Contents: 6 x 7, 8 x 9, 10 x 11, 12 x 13, 14 x 15, 16 x 17, 18 x 19, 20 x 22, 21 x 23, 24 x 26, 25 x 28, 27 x 32mm



Part No.
GED603090

GEDORE RING SPANNER DOUBLE ENDED SET 2/8M

- CHROME VANADIUM steel - 31CrV3
- Chrome Plated, polished rings
- Rings - thin walled with deep offset
- UD profile
- Contents: 6 x 7, 8 x 9, 10 x 11, 12 x 13, 14 x 15, 16 x 17, 18 x 19, 20 x 22mm



Part No.
GED603058

SPANNER - HEAVY DUTY RING - 5

- Without tubular handle
- Chrome Alloy Steel
- Chrome plated



Part No.	Size	Part No.	Size
STW42020024	24mm	STW42020050	50mm
STW42020027	27mm	STW42020052	52mm
STW42020030	30mm	STW42020055	55mm
STW42020032	32mm	STW42020060	60mm
		STW42020065	65mm

TUBULAR HANDLE - 5 1/2

- For heavy duty ring spanners No5



Part No.	Size	No
STW48030001	24-30mm	5.1/2-1
STW48030002	32-42mm	5.1/2-2
STW48030003	45-56mm	5.1/2-3
STW48030004	60-100mm	5.1/2-4

SPANNER - DOUBLE ENDED OPEN RING - ANGLED - 24

- AS-Drive
- DIN 3118/ISO 3318 (metric sizes)
- Chrome Alloy Steel
- Chrome plated



Part No.	Size
STW41080810	8 x 10mm
STW41080911	9 x 11mm
STW41081011	10 x 11mm
STW41081012	10 x 12mm
STW41081113	11 x 13mm

Part No.	Size
STW41081214	12 x 14mm
STW41081417	14 x 17mm
STW41081719	17 x 19mm
STW41081922	19 x 22mm

Part No.	Size
STW41082224	22 x 24mm
STW41082427	24 x 27mm
STW41082736	27 x 36mm
STW41083032	30 x 32mm



SPANNER - FLARE NUT

- Expert quality manufactured to DIN 3117 specifications and GS approved No 77/94
- Drop forged from chrome vanadium steel
- Has split ring on both sides to fit over pipes
- Used for fuel and gas lines



Part No.	Size	Ref.
RIC3700	9 x 10mm	25383H
RIC3701	10 x 11mm	25384H
RIC3702	10 x 12mm	25385H
RIC3703	11 x 13mm	25386H
RIC3704	12 x 13mm	25387H

Part No.	Size	Ref.
RIC3705	12 x 14mm	25388H
RIC3706	13 x 14mm	25389H
RIC3707	17 x 19mm	25392H
RIC3708	19 x 22mm	25394H



SPANNER - COMBINATION SWIVEL HEAD WRENCH - 534

- CHROME VANADIUM steel – 31CRV3
- Same size socket and open end
- Polished socket head
- Slim Pattern



Part No.	Size
GED651206	10mm
GED651214	11mm
GED651222	12mm
GED651230	13mm
GED651249	14mm

Part No.	Size
GED651257	15mm
GED651265	16mm
GED651273	17mm
GED651516	18mm
GED651281	19mm



SPANNER - DOUBLE ENDED FLEXI-JOINT - 29

- AS-Drive
- Chrome Alloy Steel
- Chrome plated



Part No.	Size
STW43010607	6 x 7mm
STW43010809	8 x 9mm
STW43011011	10 x 11mm

Part No.	Size
STW43011013	10 x 13mm
STW43011213	12 x 13mm
STW43011415	14 x 15mm
STW43011617	16 x 17mm

Part No.	Size
STW43011819	18 x 19mm
STW43012022	20 x 22mm
STW43012427	24 x 27mm
STW43013034	30 x 34mm



FLEXIBLE SOCKET - COMBINATION WRENCH SET - 6 PIECE - RT25/113D

- Drop forged from high quality chrome vanadium steel
- Accurately machined for extra strength
- Chrome plated
- Universal swivel joint socket with 12 point one end, open end flat on other
- Handy heavy duty set.
- Contents: 10, 11, 13, 15, 17, 19mm



Part No.	Size
RIC3672	6 pce



SPANNER - DOUBLE ENDED FLEXI JOINT SET 7 - 29/7

- AS-Drive
- Chrome Alloy Steel
- Chrome plated
- Contents: 29: 8 x 9, 10 x 11, 12 x 13, 14 x 15, 16 x 17, 18 x 19, 20 x 22mm



Part No.	Size
STW96430101	7 pce



SPANNER - COMBINATION SWIVEL HEAD WRENCH - SET 6 - 534/6M

- CHROME VANADIUM steel - 31CRV3
- Same size socket and open end
- Polished socket head
- Slim Pattern
- Contents: spanners: 10, 12, 13, 14, 17, 19mm



Part No.
GED651389



SPANNER - COMBINATION SWIVEL HEAD WRENCH - SET 9 - 534/9M

- CHROME VANADIUM steel - 31CRV3
- Same size socket and open end
- Polished socket head
- Slim Pattern
- Contents: spanners: 10, 11, 12, 13, 14, 15, 16, 17, 19mm



Part No.
GED651397



RATCHET SPANNER SET - 5 PIECE RT25/106D

- Heavy duty, offset type mechanic tool, permits working in tight spots
- Thumbs controlled reverses ratchet action
- Heavy duty laminated steel construction, correctly hardened and heat-treated
- Chrome plated
- 12 point opening
- Double ended ring
- Contents: 8 x 9, 10 x 11, 13 x 14, 15 x 17, 19 x 21mm



Part No.	Size
RIC3655	5 pce



RATCHET SPANNER SET - 7 PIECE RT25/717

- Drop forged from chrome vanadium steel
- Heat treated and tempered to give greater strength and toughness
- 72 teeth gear ratcheting system provides high torque and small operating angles
- Special fine gear design only needs 5° of movement allows working even in very tight spaces
- Combination ring open end spanner
- Contents: 10, 12, 13, 14, 15, 17, 19mm



Part No.	Size
RIC3656	7 pce



SPANNER - REVERSIBLE 72 TEETH **Super-Drive** One socket/spanner for every type of bolt!

- Offset ratchet spanner with quick change lever
- Manufactured to DIN3113 specifications
- Super drive spanners are the only tool you need for all varieties of bolts
- Round is not the perfect shape, six sided and wedge shaped sockets will damage bolts and nuts when transferring high forces
- Super drive spanners have a unique profile which enables the use of spanners on metric, SAE, Torx®, spline and square shaped bolts and nuts
- Chrome vanadium steel, correctly hardened and tempered for maximum strength and durability
- Satin chrome plated for corrosion protection



Part No.	Metric	Imperial	E. Nut	Ref.
RIC7860	8mm	5/16"	E10	25741H
RIC7861	9mm	11/32"	E11	25742H
RIC7862	10mm	3/8"	E12	25743H
RIC7863	11mm	7/16"	E14	25744H
RIC7864	12mm	15/32"	E14	25745H
RIC7865	13mm	1/2"	E16	25746H

Part No.	Metric	Imperial	E. Nut	Ref.
RIC7866	14mm	9/16"	E18	25747H
RIC7867	15mm	19/32"	E18	25748H
RIC7868	16mm	5/8"	E20	25749H
RIC7869	17mm	21/32"	E20	25750H
RIC7870	18mm	11/16"	E22	25751H
RIC7871	19mm	3/4"	E24	25752H

DIN
3113



SPLOGGING RING SPANNER

- Drop forged from chrome vanadium steel
- These spanners are precisely hardened and tempered and have an attractive black powder coated finish
- The design incorporates a heavy duty hexagon pattern at one end with the other end being the striking end

Part No.	Size
GRO5535	24 mm
GRO5540	27 mm
GRO5545	30 mm
GRO5550	32 mm
GRO5560	36 mm
GRO5565	38 mm
GRO5570	41 mm
GRO5571	42 mm

Part No.	Size
GRO5575	46 mm
GRO5580	50 mm
GRO5585	55 mm
GRO5590	60 mm
GRO5595	65 mm
GRO5600	70 mm
GRO5602	75 mm
GRO5604	80 mm
GRO5606	85 mm



SPANNER - STRIKING FACE RING - 4205

- DIN 7444
- Special Steel
- Grey finish

DIN
7444



Part No.	Size
STW42050024	24mm
STW42050026	26mm
STW42050027	27mm
STW42050028	28mm
STW42050030	30mm
STW42050032	32mm
STW42050033	33mm
STW42050036	36mm

Part No.	Size
STW42050037	37mm
STW42050038	38mm
STW42050041	41mm
STW42050042	42mm
STW42050046	46mm
STW42050048	48mm
STW42050050	50mm
STW42050052	52mm

Part No.	Size
STW42050055	55mm
STW42050056	56mm
STW42050060	60mm
STW42050064	64mm
STW42050065	65mm
STW42050070	70mm
STW42050075	75mm
STW42050080	80mm

Part No.	Size
STW42050085	85mm
STW42050090	90mm
STW42050095	95mm
STW42050100	100mm
STW42050105	105mm
STW42050110	110mm
STW42050115	115mm
STW42050120	120mm



SPANNER - STRIKING FACE RING - 8

- Chrome Alloy Steel
- Green painted



Part No.	Size	Part No.	Size
STW42010032	32mm	STW42010050	50mm
STW42010036	36mm	STW42010055	55mm
STW42010041	41mm	STW42010060	60mm
STW42010046	46mm	STW42010080	80mm
		STW42010085	85mm



SPANNER - STRIKING FACE RING - 4205A

- DIN 7444
- Special Steel
- Grey finish

**DIN
7444**



Part No.	Size
STW42450056	1 1/4"
STW42450070	1 7/8"



SPANNER - STRIKING FACE OPEN END - 4204

- DIN 133
- Special Tool Steel
- Grey finish



**DIN
133**

Part No.	Size	Part No.	Size
STW42040027	27mm	STW42040055	55mm
STW42040030	30mm	STW42040060	60mm
STW42040032	32mm	STW42040065	65mm
STW42040036	36mm	STW42040070	70mm
STW42040041	41mm	STW42040075	75mm
STW42040046	46mm	STW42040085	85mm
STW42040050	50mm	STW42040090	90mm

GROZ TUBE SPANNERS

tools to trust

- Manufactured from high quality steel tubing, these double ended box wrenches have a different hex socket size on each end
- Thin and long body allows these to be used to loosen or tighten nuts and bolts in narrow recessed areas
- Box wrenches are used with a tommy bar which is passed through the holes provided in the sides of the wrench



Part No.	Size	Part No.	Size
GR05650	6 x 7 mm	GR05725	18 x 19 mm
GR05700	8 x 9 mm	GR05730	20 x 21 mm
GR05705	10 x 11 mm	GR05735	22 x 23 mm
GR05710	12 x 13 mm	GR05740	24 x 25 mm
GR05715	14 x 15 mm	GR05745	26 x 27 mm
GR05720	16 x 17 mm		



BOX SPANNER - 10750

- DIN 896 type B
- Made of seamlessly drawn precision steel tubing
- Recessed at both ends
- Chrome Alloy Steel
- Surface polished and Chrome plated

**DIN
896**



Part No.	Size	Length	Part No.	Size	Length	Part No.	Size	Length
STW43320607	6 x 7mm	110mm	STW43321213	12 x 13mm	140mm	STW43321719	17 x 19mm	160mm
STW43320809	8 x 9mm	110mm	STW43321415	14 x 15mm	140mm	STW43321819	18 x 19mm	160mm
STW43321011	10 x 11mm	120mm	STW43321617	16 x 17mm	150mm	STW43322022	20 x 22mm	170mm



TUBE SPANNER SET - 6 PIECE

- Double ended, 8 - 17mm high quality alloy steel
- Tommy bar included
- Contents: 8x10, 12x13, 14x15, 16x17mm

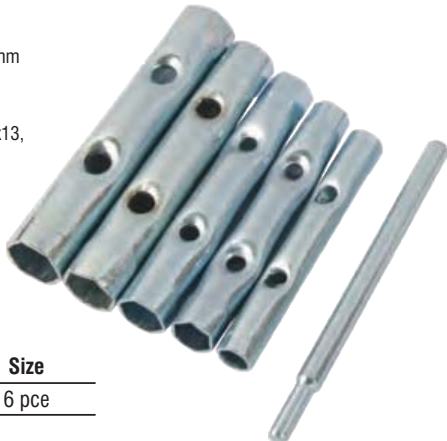

Part No.	Size
HON8058	6 pce



SPANNER - BOX - SET 7 PIECE RT6/507

- Heavy gauge steel cadmium plated tool set
- Hexagon socket ends with tommy bar
- Vinyl roll up wallet
- Contents: 8 x 9, 10 x 11, 12 x 13, 14 x 15, 16 x 17, 18 x 19mm



Part No.	Size
RIC3675	7 pce

GROZ **TUBE SPANNER SET - BA SERIES**
tools to trust **8 PIECE**

- Supplied with tommy bar
- Hexagon on both ends
- Contents: 0 x 1, 2 x 3, 4 x 5, 6 x 7, 8 x 9 & 10 BA (single ended)



Code
GRO5525

GROZ **TUBE SPANNER SET - 8 PIECE**
tools to trust

- Supplied with 2 tommy bars
- Hexagon on both ends
- Contents: 8 x 9, 10 x 11, 12 x 13, 14 x 15, 16 x 17, 18 x 19 mm



Code
GRO5750

STAWHILLE **BOX SPANNER SET 7 PIECES - 10750/7**

- DIN 896 type B
- Made of seamlessly drawn precision steel tubing
- Recessed at both ends
- Chrome Alloy Steel
- Surface polished and Chrome plated
- Contents: 10750:
- 8 x 9, 10 x 11, 12 x 13, 14 x 15, 16 x 17, 18 x 19, 20 x 22mm



Part No.	Size
STW96431201	7 pce

STAWHILLE **BOX SPANNER SET 11 PIECES - 10750/11**

- DIN 896 type B
- Made of seamlessly drawn precision steel tubing
- Recessed at both ends
- Chrome Alloy Steel
- Surface polished and Chrome plated
- Contents 10750:
- 6 x 7, 8 x 9, 10 x 11, 12 x 13, 14 x 15, 16 x 17, 18 x 19, 20 x 22, 21 x 23, 24 x 27, 30 x 32mm



Part No.	Size
STW96431204	11 pce

MTS **2-IN-1 COMBINATION SPARK PLUG SPANNER**

- Patented 2-in-1 spark plug tool for 16 and 21mm spark plugs
- Automatically snap on the plugs
- Swivel action head has a flexible spring to keep right direction steady



Part No.	Size
HON8057	16 / 21mm

2in1 +

RACO **SPANNER - SPARK PLUG COMBO 2-IN-1 RT6/515B**

- Patented 2-in-1 spark plug tool for 16 and 21mm spark plugs
- Automatically snap on the plugs
- Swivel action head has a flexible spring to keep right direction steady
- Heavy duty quality construction, made from drop forged alloy steel, heat treated
- Chrome plated with neoprene insert to protect plugs
- Insulated type T-handle for extra leverage



Part No.	Size
RIC3657	16/21mm

2in1 +

RACO **SPARK PLUG SPANNER - RT6/512B**

- Swivel action socket with rubber insert grips tightly
- Drop forged alloy steel, chrome plated
- Vinyl cushion grip T handle



Part No.	Size
RIC3660	16mm

RACO **SPARK PLUG SPANNER - RT6/511B**

- Swivel action socket with rubber insert grips tightly
- Drop forged alloy steel, chrome plated
- Vinyl cushion grip T handle



Part No.	Size
RIC3665	21mm



SPARK PLUG SPANNER - MAGNETIC RT6/517C

- High torque socket with flank drive, manufactured from high quality chrome vanadium steel
- Chrome plated recess with power magnetic holder to give safe and securing grips
- Flexible head contoured "T" type handle of chrome vanadium steel
- Soft grip for extra leverage and comfort operating



Part No.	Size	Length
RIC3668	16mm	350mm



SPARK PLUG SPANNER - MAGNETIC RT6/518C

- High torque socket with flank drive, manufactured from high quality chrome vanadium steel
- Chrome plated recess with power magnetic holder to give safe and securing grips
- Flexible head contoured "T" type handle of chrome vanadium steel
- Soft grip for extra leverage and comfort operating



Part No.	Size	Length
RIC3669	21mm	350mm



SPARK PLUG TOOL SET 3/8" DRIVE MAGNETIC 3 PIECE - RT6/519C

- High torque socket with flank drive, manufactured from high quality chrome vanadium steel
- Chrome plated recess with power magnetic holder to give safe and securing grips
- 3/8" drive contoured "T" type handle of chrome vanadium steel
- Soft grip for extra leverage

- and comfortable operation
- Contents: 3/8" drive sockets 16, 21mm



Part No.	Length
RIC3667	290mm



TUBULAR SPARK PLUG SOCKET - 1042

- Extra-long spark plug socket
- Knurled end for finger turning
- 16mm-5/8" x 270mm



Part No.	Size
STW02230016	16mm



SPARK PLUG SPANNER & T BAR - 58

- CHROME VANADIUM steel 31CrV3
- Hot-forged socket head with plug retainer, swivel joint
- Chrome plated



Part No.	Size
GED636347	16 x 301mm



SPARK PLUG SPANNER & T BAR - 58

- CHROME VANADIUM steel 31CrV3
- Hot-forged socket head with plug retainer, swivel joint
- Chrome plated



Part No.	Size
GED636312	20.8 x 500mm



WHEEL SPANNER - EXTENDABLE RT6/610B

- Manufactured to DIN standards with GS quality approval
- A useful tool for removing wheel nuts quickly and easily with one hand
- This extendable spanner is ideal for loosening stubborn nuts in the fully extended position (550mm)
- Tightening nuts without stripping in the closed position (400mm)
- High torque steel shaft has 1/2" drive with a 45° angle end
- Can be used with any 1/2" drive accessories for high torque applications

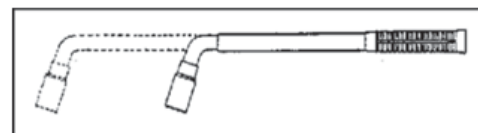
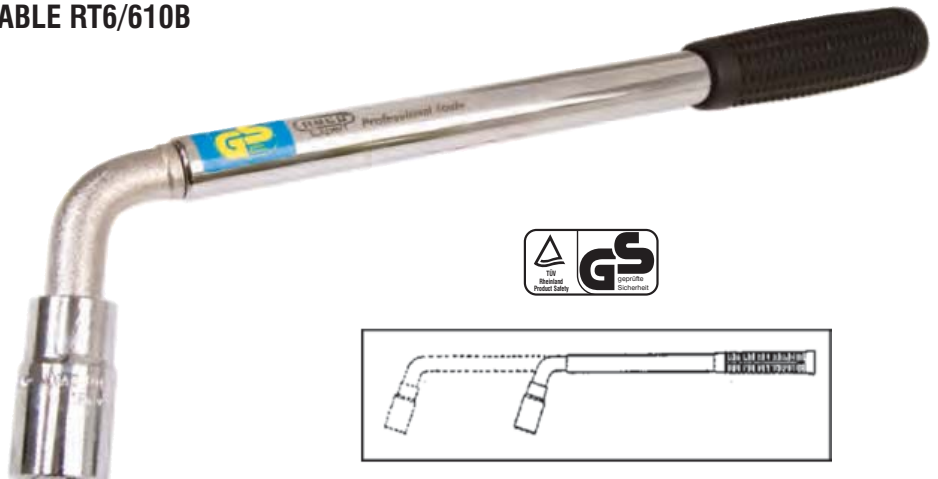

Part No.	Size
RIC3680	19x21mm

Automotive

GROZ WHEEL SPANNER - DOUBLE ENDED

tools to trust

- Heavy duty, double ended wheel spanner
- High grade alloy steel
- Rust preventing bright nickle finish
- **Supplied without tommy bar**
- Spare tommy bars are available



Code	Size	Code	Size
GRO5970	24 x 27 mm	GRO6040	27 x 33 mm
GRO6000	27 x 30 mm	GRO6070	30 x 32 mm
GRO6020	27 x 32 mm	GRO6075	30 x 33 mm
		GRO6080	32 x 38 mm
		GRO6090	38 x 21 Sq.
		GRO6095	41 x 21 Sq.

GROZ TOMMY BAR -FOR WHEEL SPANNER

tools to trust

- Heavy duty tommy bar
- Used with double ended wheel spanner
- High grade alloy steel
- Rust preventing bright nickle finish



Code	Size
GRO6120	430mm

GEDORE WHEEL SOCKET WRENCH - TRUCKS - 27

Tools For Life

- CHROME VANADIUM steel 31CrV3
- Chrome plated



Part No.	Size
GED026150	27 x 30mm

GEDORE WHEEL SOCKET WRENCH – TRUCKS - SPARE BAR 27D/35D

Tools For Life

- CHROME VANADIUM steel 31CrV3
- Chrome plated

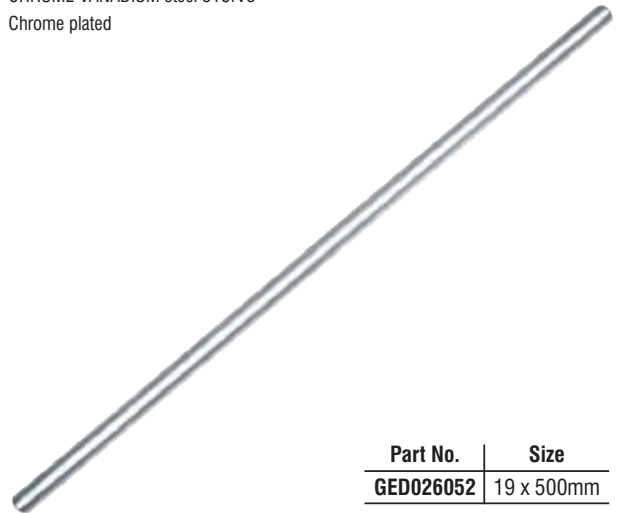

Part No.	Size
GED026052	19 x 500mm

BRITO WHEEL SPANNER - HEAVY DUTY

- Sockets are made from best grade chrome vanadium steel
- Hardened and heat treated to ensure that they are normalised and non warping
- Heavy double ended sockets
- Extra thick shaft
- Uses Tommy Bar heavy duty (Extra)



Part No.	Size
BRI9200	24x27mm
BRI9205	27x30mm
BRI9210	27x32mm
BRI9215	27x33mm
BRI9220	30x32mm
BRI9225	30x33mm
BRI9235	38x21mm
BRI9240	41x21mm

BRITO WHEEL SPANNER - TOMMY BAR

- Heavy duty
- Same quality as the Brito Impact sockets
- Extra thick shaft
- Use on all wheel spanners



Part No.	Size
BRI9260	500x20mm

GEDORE Back For Life **4-WAY WHEEL WRENCH - 28PU**

- CHROME VANADIUM steel 31CrV3
- Blue epoxy powder coated

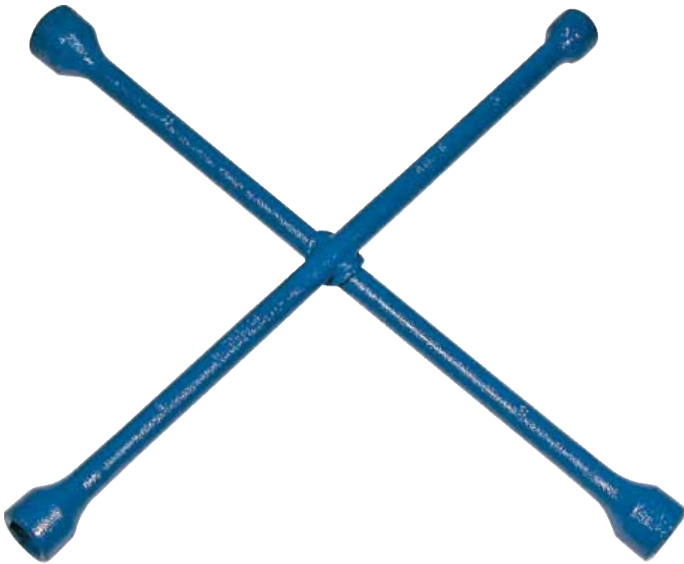

Part No.	Size
GED622761	17x19mm & 21x22mm

GEDORE Back For Life **4-WAY WHEEL WRENCH - 28CV**

- CHROME VANADIUM steel 31CrV3
- Blue epoxy powder coated

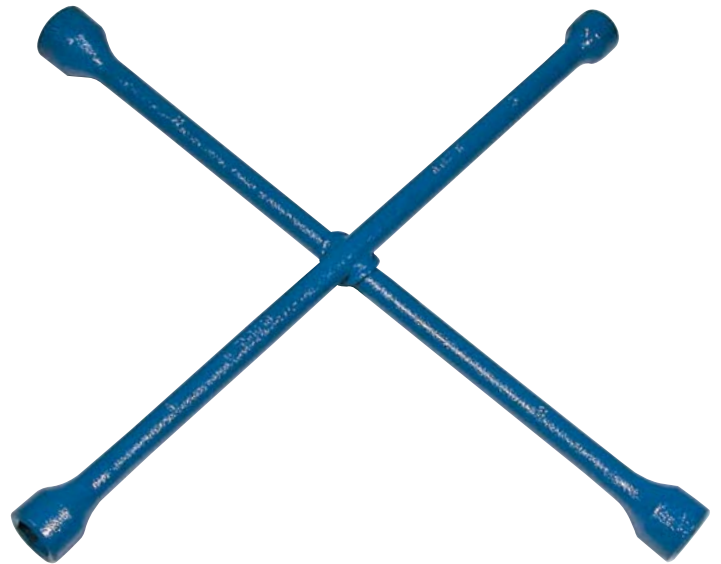

Part No.	Size
GED622869	19x20mm & 24x27mm



UNIVERSAL KEY - ELECTRICAL - 4 WAY

- Multipurpose - electrical panels, gas, etc
- Made from die cast zinc
- Ideal for maintenance work
- Double Bit
- 8mm Triangle Female
- 6mm Square Female
- 8mm Square Female



Code	Size
BTH0500	-



SPANNER - ADJUSTABLE HOOK - 12910

- For slotted nuts as per DIN 1810



Part No.	Size	No
STW44010001	20-42mm	12910/1
STW44010002	45-90mm	12910/2
STW44010003	95-165mm	12910/3

Automotive



the Raco System



Hardened chrome vanadium steel with satin peened surface for anti-corrosion

12 point Bi-Hex flank drive sockets drive nut on the sides without distortion even on rusty parts

Quick release mechanism secures sockets on the square drive

Quick switch from clockwise to anti-clockwise

72 tooth ratchet allows for 5 degrees working arc in confined spaces



RACO PROFESSIONAL QUALITY CHROME VANADIUM SOCKETS

- Expert, professional quality sockets manufactured to **DIN 3120** & **DIN 3124** specifications from chrome vanadium steel, correctly hardened and tempered for maximum strength
- Chamfered ends allow for positive location and entry
- Professional satin chrome finish for maximum corrosion protection
- All sockets are packaged on a convenient plastic hanger with clear markings



HEX SOCKET - 1/4" DRIVE

- Manufactured to DIN 3124
- Manufactured from chrome vanadium steel
- Hardened and tempered for maximum strength
- Chamfered ends allow positive nut location and entry
- Satin chrome plated for corrosion protection



Code	Size	Ref.	Code	Size	Ref.	Code	Size	Ref.
RIC7580	4mm	5V232	RIC7588	6mm	5V236	RIC7596	10mm	5V240
RIC7582	4.5mm	5V233	RIC7590	7mm	5V237	RIC7598	11mm	5V241
RIC7584	5mm	5V234	RIC7592	8mm	5V238	RIC7600	12mm	5V242
RIC7586	5.5mm	5V235	RIC7594	9mm	5V238	RIC7602	13mm	5V244
						RIC7604	14mm	5V245



Raco Super-Drive

Streaks ahead in cost-cutting action, the Raco Super Drive Socket/Spanner is the only tool you need for all varieties of bolts. Round is not the perfect shape, six sided and wedge shaped sockets will damage bolts and nuts when transferring high forces.

The rings of the RACO® Super Drive combination spanner have a unique profile which enables the use of the spanner on Metric, SAE, Torx, Spline and Square shaped bolts and nuts.

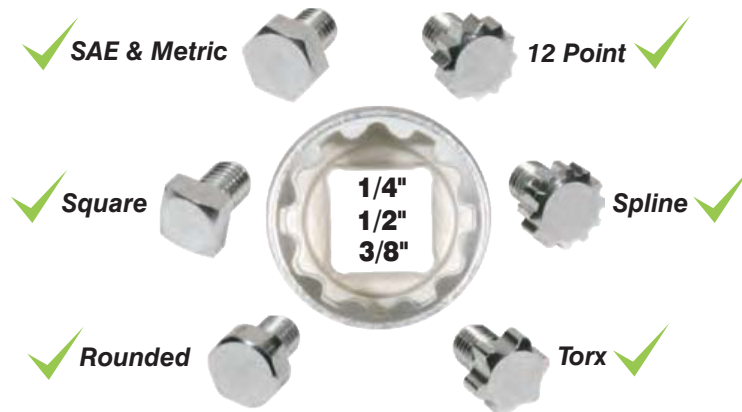

Super-Drive

One socket/spanner for every type of bolt!



HEX SOCKET - 1/4" DRIVE - 40

1/4"

- Stahlwille HPQ (high performance quality) sockets are manufactured from selected tough steel alloys
- Their extremely thin walls and unbelievably high load capacity are simply exemplary
- Stahlwille sockets are equipped with the AS Drive (anti slip drive) profile
- This permits high transmission of forces to lands of nuts and bolts without damaging them



Code	Size	Code	Size	Code	Size
STW01010005	5mm	STW01010009	9mm	STW01010012	12mm
STW01010055	5.5mm	STW01010011	11mm	STW01010014	14mm



HEX SOCKET - 1/4" DRIVE - 40A

- Stahlwille HPQ (high performance quality) sockets are manufactured from selected tough steel alloys
- Their extremely thin walls and unbelievably high load capacity are simply exemplary
- Stahlwille sockets are equipped with the AS Drive (anti slip drive) profile
- This permits high transmission of forces to lands of nuts and bolts without damaging them



Code	Size	Code	Size	Code	Size
STW01410012	3/16"	STW01410020	5/16"AF	STW01410028	7/16"
STW01410014	7/32"	STW01410022	11/32"	STW01410032	1/2"
STW01410016	1/4"	STW01410024	3/8"AF	STW01410034	9/16"

Automotive

1/4" Sockets 108

1/4"



HEX SOCKET - 1/4" DRIVE - LONG

- Manufactured to DIN 3124
- Manufactured from chrome vanadium steel

- Hardened and tempered for maximum strength
- Chamfered ends allow positive nut location and entry
- Satin chrome plated for corrosion protection



Code	Size	Ref.	Code	Size	Ref.	Code	Size	Ref.
RIC7610	5mm	4V223	RIC7614	8mm	4V227	RIC7617	11mm	4V230
RIC7611	5.5mm	4V224	RIC7615	9mm	4V228	RIC7648	12mm	4V231
RIC7612	6mm	4V225	RIC7616	10mm	4V229	RIC7619	13mm	4V232
RIC7613	7mm	4V226						



HEX SOCKET - 1/4" DRIVE - LONG - 40L

- Stahlwille HPQ (high performance quality) sockets are manufactured from selected tough steel alloys
- Their extremely thin walls and unbelievably high load capacity are simply exemplary
- Stahlwille sockets are equipped with the AS Drive (anti slip drive) profile
- This permits high transmission of forces to lands of nuts and bolts without damaging them



Code	Size	Code	Size	Code	Size
STW01020055	5.5mm	STW01020010	10mm	STW01020012	12mm
STW01020007	7mm	STW01020011	11mm	STW01020013	13mm
STW01020008	8mm				



SOCKET TORX - 1/4" DRIVE

- Expert professional quality socket
- Manufactured to DIN 3120 specifications
- Manufactured from Chrome vanadium steel with high quality S2 screwdriver head
- Correctly hardened and tempered and precision machined to deliver maximum turning power
- Satin chrome plated for corrosion protection
- Length 32mm



Code	Size	Ref.	Code	Size	Ref.	Code	Size	Ref.
RIC7355	T8	5V121	RIC7357	T15	5V123	RIC7360	T27	5V126
RIC7356	T10	5V122	RIC7358	T20	5V124	RIC7361	T30	5V127
			RIC7359	T25	5V125	RIC7362	T40	5V128



TORX® SOCKET - 1/4" DRIVE - 40TX

- For external TORX® screws
- HPQ high performance steel
- Chrome plated



Code	Size	Code	Size	Code	Size
STW01270006	E6	STW01270008	E8	STW01270010	E10



ALLENKEY SOCKET - 1/4" DRIVE

- Expert professional quality socket
- Manufactured to DIN 3120 specifications
- Manufactured from Chrome vanadium steel with high quality S2 screwdriver head
- Correctly hardened and tempered and precision machined to deliver maximum turning power
- Satin chrome plated for corrosion protection
- Length 32mm



Code	Size	Ref.	Code	Size	Ref.	Code	Size	Ref.
RIC7343	3mm	5V061	RIC7345	5mm	5V063	RIC7348	8mm	5V065
RIC7344	4mm	5V062	RIC7346	6mm	5V064	RIC7349	10mm	5V066



INHEX SOCKET - 1/4" DRIVE 44

- For socket head screws
- Chrome Alloy steel
- DIN 7422
- Length 30mm



Code	Size	Code	Size	Code	Size
STW01050003	3mm	STW01050005	5mm	STW01050006	6mm
STW01050004	4mm				



ADAPTOR - 1/4" DRIVE - 5V275

- Manufactured from Chrome Vanadium steel, hardened and tempered for maximum strength and durability
- Manufactured to DIN3122 & 3123
- Square drive incorporates spring loaded retaining ball for securing sockets
- Satin chrome plated for corrosion protection



Code	Size
RIC7530	1/4"F - 3/8"M



REDUCER (ADAPTOR) - 1/4" DRIVE

- DIN 3123/ISO 3316
- HPQ HIGH PERFORMANCE STEEL
- Chrome plated
- 1/4" socket x 3/8" plug (6.3 x 10)



Code	Ref	Length
STW11030002	409	25mm



REDUCER (ADAPTOR) 1/4" DRIVE

- DIN 3123/ISO 3316
- HPQ HIGH PERFORMANCE STEEL
- Chrome plated
- 1/4" socket x 1/2" plug (6.3 x 12.5)



Code	Ref	Length
STW11030003	410	28mm



UNIVERSAL JOINT - 1/4" DRIVE - 5V273

- Manufactured to DIN3122 & 3123
- Manufactured from chrome vanadium steel
- Satin chrome plated for corrosion protection
- Correctly hardened and tempered for max. strength and durability
- Square drive incorporates spring loaded retaining ball for secure socket holding



Code	Size
RIC7980	1/4" x 40mm

Automotive



UNIVERSAL JOINT 1/4" DRIVE

- DIN 3123/ISO 3316
- Chrome alloy steel
- Chrome plated



Code	Ref	Length
STW11020000	407	37mm



EXTENSIONS 1/4" DRIVE

- Manufactured to DIN 3123/ISO 3316
- Forged from Finest quality steel



Code	Ref	Length
STW11010001	405/2	54mm
STW11010002	405/6	150mm
STW11010014	405/14	356mm



SLIDING T-HANDLE - 1/4" DRIVE

- DIN 3122/ISO 3315
- Chrome alloy steel
- Chrome plated



Code	Ref	Length
STW11070000	404	116mm



POWER BAR (FLEXIBLE HANDLE) 1/4" DRIVE

- Manufactured to DIN 3122/ISO 3315
- Forged from Finest quality steel
- With 2-component handle



Code	Ref	Length
STW11061010	403	154.5mm



EXTENSIONS - 1/4" DRIVE

- Manufactured to DIN3122 & 3123
- Manufactured from chrome vanadium steel
- Correctly hardened and tempered for maximum strength and durability
- Square drive incorporates spring loaded retaining ball for secure socket holding
- Satin chrome plated for corrosion protection



Code	Size	Ref.
RIC7400	1/4" x 50mm	5V252T
RIC7405	1/4" x 150mm	5V254



SLIDING T-BAR - 1/4" DRIVE - 5V251

- Manufactured to DIN3122 & 3123
- Manufactured from chrome vanadium steel
- Correctly hardened and tempered for maximum strength and durability
- Square drive incorporates spring loaded retaining ball for secure socket holding
- Satin chrome plated for corrosion protection



Code	Size
RIC7950	1/4" x 115mm



REVERSIBLE RATCHET - 1/4" DRIVE - 72 TEETH 5V293

- High torque, manufactured to DIN 3122 specification
- Dropped forged from one piece chrome vanadium steel
- Heat treated to obtain maximum hardness and precision machined
- for rugged strength and dependability
- Reversible 72 teeth heavy duty ratchet mechanism with quick release
- and quick changeover lever
- Satin finish



Code	Size
RIC7500	1/4"Dr x 150mm



SPINNER HANDLE - 1/4" DRIVE - 5V241

- Additional 1/4" Drive in end of handle
- High impact plastic handle
- Chrome Vanadium steel, tempered and hardened



Code	Size
RIC7455	1/4" x 150mm



DRIVE HANDLE - 1/4" DRIVE

- DIN 3122/ISO 3315 specification
- Manufactured from chrome alloy steel
- Chrome plated
- With 2-component handle



Code	Ref	Length
STW11050010	400	150mm
STW11050002	401	230mm

1/4"

Automotive

3/8"



BI-HEX SOCKETS - 3/8" DRIVE

- Manufactured to DIN 3124
- Manufactured from chrome vanadium steel
- Hardened and tempered for maximum strength
- Chamfered ends allow positive nut location and entry
- Satin chrome plated for corrosion protection



Code	Size	Ref.	Code	Size	Ref.	Code	Size	Ref.
RIC7650	6mm	5V330T	RIC7655	11mm	5V335T	RIC7659	15mm	5V339T
RIC7651	7mm	5V331T	RIC7656	12mm	5V336T	RIC7661	17mm	5V341T
RIC7652	8mm	5V332T	RIC7657	13mm	5V337T	RIC7663	19mm	5V343T
RIC7653	9mm	5V333T	RIC7658	14mm	5V338T	RIC7664	22mm	5V345T



SUPER DRIVE SOCKETS - 3/8" DRIVE

Super-Drive

- Super drive socket is the only tool you need for all varieties of bolts
- Round is not the perfect shape, six sided and wedge shaped sockets will damage bolts and nuts when transferring high forces
- Super drive sockets have a unique profile which enables the use of sockets on metric, SAE, Torx®, spline and square shaped bolts and nuts
- Chrome vanadium steel, correctly hardened and tempered for maximum strength and durability
- Satin chrome plated for corrosion protection



Code	Metric	Imp.	E.Nut	Ref.	Code	Metric	Imp.	E.Nut	Ref.
RIC7740	6mm	1/4"	E8	4V351H	RIC7747	13mm	1/2"	E16	4V358H
RIC7741	7mm	9/32"	E9	4V352H	RIC7748	14mm	9/16"	E18	4V359H
RIC7742	8mm	5/16"	E10	4V353H	RIC7749	15mm	19/32"	E18	4V360H
RIC7743	9mm	11/32"	E11	4V354H	RIC7750	16mm	5/8"	E20	4V361H
RIC7744	10mm	3/8"	E12	4V355H	RIC7751	17mm	21/32"	E20	4V362H
RIC7745	11mm	7/16"	E14	4V356H	RIC7752	18mm	11/16"	E22	4V363H
RIC7746	12mm	15/32"	E14	4V357H	RIC7753	19mm	3/4"	E24	4V364H



BI-HEX SOCKETS - 3/8" DRIVE - 45

- Stahlwille HPQ (high performance quality) sockets are manufactured from selected tough steel alloys
- Their extremely thin walls and unbelievably high load capacity are simply exemplary
- Stahlwille sockets are equipped with the AS Drive (anti slip drive) profile
- This permits high transmission of forces to lands of nuts and bolts without damaging them



Code	Size	Code	Size	Code	Size
STW02010008	8mm	STW02010011	11mm	STW02010016	16mm
STW02010009	9mm	STW02010013	13mm	STW02010017	17mm
STW02010010	10mm	STW02010014	14mm	STW02010018	18mm



BI-HEX DEEP SOCKETS - 3/8" DRIVE - 46

- Stahlwille HPQ (high performance quality) sockets are manufactured from selected tough steel alloys
- Their extremely thin walls and unbelievably high load capacity are simply exemplary
- Stahlwille sockets are equipped with the AS Drive (anti slip drive) profile
- This permits high transmission of forces to lands of nuts and bolts without damaging them



Code	Size	Code	Size	Code	Size
STW02020008	8mm	STW02020012	12mm	STW02020017	17mm
STW02020010	10mm	STW02020013	13mm	STW02020020	20.8mm
STW02020011	11mm	STW02020014	14mm		



HEX SOCKETS - 3/8" DRIVE - 30

- For manually operated sockets with thin walls and knurled base
- CHROME VANADIUM steel 31CrV3
- Chrome plated and polished



Code	Size	Code	Size
GED623016	6mm	GED623059	10mm
GED623024	7mm	GED623210	1/4"
GED623032	8mm	GED623253	3/8"
GED623040	9mm		



BI-HEX SOCKETS - 3/8" DRIVE - D30

- For manually operated sockets with thin walls and knurled base
- CHROME VANADIUM steel 31CrV3
- Chrome plated and polished



Code	Size	Code	Size	Code	Size
GED623067	11mm	GED623091	14mm	GED623148	18mm
GED623075	12mm	GED623105	15mm	GED623156	19mm
GED623083	13mm	GED623113	16mm	GED623164	20mm
		GED623121	17mm	GED623180	22mm



BI-HEX DEEP SOCKETS - 3/8" DRIVE - 46A

- Stahlwille HPQ (high performance quality) sockets are manufactured from selected tough steel alloys
- Their extremely thin walls and unbelievably high load capacity are simply exemplary
- Stahlwille sockets are equipped with the AS Drive (anti slip drive) profile
- This permits high transmission of forces to lands of nuts and bolts without damaging them



Code	Size
STW02420032	1/2"
STW02420034	9/16"
STW02420040	3/4"



SPARK PLUG SOCKETS - 3/8" DRIVE

- With flank drive
- Manufactured to high quality standards from chrome vanadium steel hardened and tempered for maximum strength
- Professional look two colour satin chrome finish
- Fitted with rubber plug protection insert



Code	Size	Ref.
RIC7621	3/8" x 14mm	4V372
RIC7620	3/8" x 16mm	6V501B
RIC7622	3/8" x 21mm	6V502B

Automotive

111 3/8" Sockets

AVAILABLE FROM SELECTED DISTRIBUTORS NATIONWIDE



SOCKET - INHEX 3/8" DRIVE - 49

- For socket head screws
- DIN7422
- Chrome Alloy steel
- Chrome plated



Code	Size	Code	Size	Code	Size
STW02050003	3mm	STW02050005	5mm	STW02050007	7mm
STW02050004	4mm	STW02050006	6mm	STW02050008	8mm
				STW02050010	10mm



SOCKET - INHEX 3/8" DRIVE - 49A

- For socket head screws
- DIN7422
- Chrome Alloy steel
- Chrome plated



Code	Size	Code	Size	Code	Size
STW02450014	7/32"	STW02450016	1/4"	STW02450024	3/8"



SOCKET WITH HEXAGON INSERT BIT 3/8" DRIVE - IN30

- For hexagon head screws
- Manually operated sockets with knurled base
- Sockets - Chrome Vanadium steel - 31CrV3
- Bits - Chrome vanadium steel - 59CrV4



Code	Size	Length
GED624101	4mm	28mm
GED624128	5mm	28mm
GED624136	6mm	28mm
GED624144	8mm	28mm
GED624292	10mm	28mm



ADAPTOR - 3/8" DRIVE

- Manufactured from Chrome Vanadium steel, hardened and tempered
- For maximum strength and durability
- Manufactured to DIN3122 & 3123
- Square drive incorporates spring loaded retaining ball for securing sockets
- Satin chrome plated for corrosion protection



Code	Size	Ref.
RIC7535	3/8"F - 1/4"M	5V375
RIC7536	3/8"F - 1/2"M	5V376



REDUCER (ADAPTOR) - 3/8" DRIVE

- DIN 3123/ISO 3316
- HPQ High performance steel
- Chrome plated
- 3/8" socket x 1/4" plug (10 x 6.3)
- Maximum torque 62Nm



Code	Ref	Length
STW12030001	431	28mm



REDUCER (ADAPTOR) - 3/8" DRIVE

- DIN 3123/ISO 3316
- HPQ High performance steel
- Chrome plated
- 3/8" socket x 1/2" plug (10 x 12.5)



Code	Ref	Length
STW12030003	432	31mm



REDUCER - 3020 - 3/8" DRIVE

- For manually operated sockets and accessories with 3/8" square drive
- CHROME VANADIUM steel 31CrV3
- 3/8" female to 1/4" male



Code	Length
GED623628	28mm



CONVERTER - 3019 - 3/8" DRIVE

- For manually operated sockets and accessories with 3/8" square drive
- CHROME VANADIUM steel 31CrV3
- 3/8" female to 1/2" male



Code	Length
GED623601	36mm

3/8"



UNIVERSAL JOINT - 3/8" DRIVE - 5V373

- Manufactured to DIN3122 & 3123
- Manufactured from chrome vanadium steel
- Correctly hardened and tempered for maximum strength and durability
- Square drive incorporates spring loaded retaining ball for secure socket holding
- Satin chrome plated for corrosion protection



Code	Size
RIC7982	3/8" x 50mm



UNIVERSAL JOINT - 3/8" DRIVE

- DIN 3123/ISO 3316
- Chrome alloy steel
- Chrome plated



Code	Ref	Length
STW12020000	428	46mm



UNIVERSAL JOINT - 3095 - 3/8" DRIVE

- For manually operated sockets and accessories with 3/8" square drive
- CHROME VANADIUM steel – 31CrV3 & 59CrV4



Code	Length
GED623814	54mm



COUPLER - 3094 - 3/8" DRIVE

- For manually operated sockets and accessories with 3/8" square drive
- CHROME VANADIUM steel 59CrV4



Code	Length
GED623776	29mm



EXTENSIONS - 3/8" DRIVE

- Manufactured to DIN3122 & 3123
- Manufactured from chrome vanadium steel
- Correctly hardened and tempered for maximum strength and durability
- Square drive incorporates spring loaded retaining ball for secure socket holding
- Satin chrome plated for corrosion protection



Code	Size	Ref.
RIC7410	3/8" x 75mm	5V352
RIC7415	3/8" x 150mm	5V353H



EXTENSIONS 3/8" DRIVE

- Manufactured to DIN 3123/ISO 3316
- Forged from Finest quality steel



Code	Ref	Length
STW12010005	427/1.5	38mm
STW12010003	427/10	240mm



EXTENSIONS - 3090 - 3/8" DRIVE

- For manually operated sockets and accessories with 3/8" square drive
- CHROME VANADIUM steel 31CrV3



Code	Length
GED623660	75mm
GED623679	125mm
GED623687	250mm



EXTENSION 3/8" DRIVE - FLEXIBLE

- Maximum torque 7Nm
- Right hand rotation only
- NO LOOSENING



Code	Ref	Length
STW12040000	434	194mm



SLIDING T-BAR - 3/8" DRIVE

- Manufactured to DIN3122 & 3123
- Manufactured from chrome vanadium steel
- Correctly hardened and tempered for maximum strength and durability
- Square drive incorporates spring loaded retaining ball for secure socket holding
- Satin chrome plated for corrosion protection



Code	Size	Ref.
RIC7955	3/8" x 165mm	5V351



SLIDING T-HANDLE - 3/8" DRIVE

- DIN 3122ISO 3315
- Chrome alloy steel
- Chrome plated



Code	Ref	Length
STW12070000	425	165mm

Automotive

GEDORE Tools For Life **SLIDING T BAR - 3087 - 3/8" DRIVE**

- For manually operated sockets and accessories with 3/8" square drive
- CHROME VANADIUM steel 31CrV3



Code	Length
GED623652	160mm

STAHLWILLE **RATCHET - 3/8" DRIVE**

- DIN 3122/ISO 3315 specification
- Manufactured from chrome alloy steel
- Chrome plated
- Reversible, 30 teeth
- With 2 - component handle



Code	Ref	Length
STW12111010	435	193mm

GEDORE Tools For Life **RATCHET - REVERSIBLE & COUPLER - 3/8" DRIVE - 3093Z/94**

- For manually operated sockets and accessories with 3/8" square drive
- CHROME VANADIUM steel 31CrV3
- 20° Ratchet arch



Code	Length
GED623768	180mm

STAHLWILLE **POWER BAR - 3/8" DRIVE**

- Manufactured to DIN 3122/ISO 3315
- Forged from Finest quality steel
- With 2-component handle



Code	Ref	Length
STW12060010	424	253.5mm

RACO **REVERSIBLE RATCHET - 1/4" DRIVE 72 TEETH - 5V393**

- High torque, manufactured to DIN 3122 specification
- Dropped forged from one piece chrome vanadium steel
- Heat treated to obtain maximum hardness and precision machined for rugged strength and dependability
- Reversible 72 teeth heavy duty ratchet mechanism with quick release and quick changeover lever
- Satin finish



Code	Size
RIC7505	3/8"Dr x 205mm

GEDORE Tools For Life **RATCHET - 3093-U3 - 3/8" DRIVE**

- For manually operated sockets and accessories with 3/8" square drive
- CHROME VANADIUM steel 31CrV3
- 5° Ratchet arch



Code	Length
GED623709	180mm

RACO **POWER BAR - 3/8" DRIVE - 5V371**

- Manufactured from Chrome Vanadium steel, hardened and tempered for maximum strength and durability
- Manufactured to DIN3122 & 3123
- Square drive incorporates spring loaded retaining ball for securing sockets



Code	Size
RIC7470	3/8" x 215mm

GEDORE Tools For Life **POWER BAR - 3/8" DRIVE - 3096**

- For manually operated sockets and accessories with 3/8" square drive
- CHROME VANADIUM steel - 31CrV3



Code	Length
GED623822	250mm

3/8"

Automotive

1/2"



BI-HEX SOCKETS - 1/2" DRIVE

- Manufactured to DIN 3124
- Manufactured from chrome vanadium steel
- Hardened and tempered for maximum strength
- Chamfered ends allow positive nut location and entry
- Satin chrome plated for corrosion protection



Code	Size	Ref.
RIC7708	8mm	5V428
RIC7709	9mm	5V429
RIC7710	10mm	5V430
RIC7711	11mm	5V431
RIC7712	12mm	5V432
RIC7713	13mm	5V433
RIC7714	14mm	5V434
RIC7715	15mm	5V435
RIC7716	16mm	5V436

Code	Size	Ref.
RIC7717	17mm	5V437
RIC7718	18mm	5V438
RIC7719	19mm	5V439
RIC7720	20mm	5V440
RIC7721	21mm	5V441
RIC7722	22mm	5V442
RIC7723	23mm	5V443
RIC7724	24mm	5V444
RIC7725	25mm	5V422

Code	Size	Ref.
RIC7726	26mm	5V423
RIC7727	27mm	5V445
RIC7728	28mm	5V424
RIC7729	29mm	5V425
RIC7730	30mm	5V446
RIC7732	32mm	5V447
RIC7733	33mm	5V428
RIC7736	36mm	5V450



SUPER DRIVE SOCKETS - 1/2" DRIVE

Super-Drive

- Super drive socket is the only tool you need for all varieties of bolts
- Round is not the perfect shape, six sided and wedge shaped sockets will damage bolts and nuts when transferring high forces
- Super drive sockets have a unique profile which enables the use of sockets on metric, SAE, Torx®, spline and square shaped bolts and nuts
- Chrome vanadium steel, correctly hardened and tempered for maximum strength and durability
- Satin chrome plated for corrosion protection

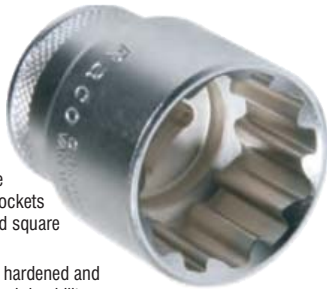

Code	Metric	Imp.	E. Nut	Ref.
RIC7760	8mm	5/16"	E10	4V451H
RIC7761	9mm	11/32"	E11	4V452H
RIC7762	10mm	3/8"	E12	4V453H
RIC7763	11mm	7/16"	E14	4V454H
RIC7764	12mm	15/32"	E14	4V455H
RIC7765	13mm	1/2"	E16	4V456H
RIC7766	14mm	9/16"	E18	4V457H
RIC7767	15mm	19/32"	E18	4V458H
RIC7768	16mm	5/8"	E20	4V459H
RIC7769	17mm	21/32"	E20	4V460H
RIC7770	18mm	11/16"	E22	4V461H
RIC7771	19mm	3/4"	E24	4V462H

Code	Metric	Imp.	E. Nut	Ref.
RIC7772	20mm	25/32"	E25	4V463H
RIC7773	21mm	13/16"	E26	4V464H
RIC7774	22mm	7/8"	E28	4V465H
RIC7775	23mm	29/32"	E28	4V466H
RIC7776	24mm	15/16"	E30	4V467H
RIC7777	25mm	31/32"	E32	4V468H
RIC7778	26mm	1"	E32	4V469H
RIC7779	27mm	1 1/16"	E34	4V470H
RIC7780	28mm	1 3/32"	E36	4V471H
RIC7781	29mm	1 1/8"	E36	4V472H
RIC7782	30mm	1 3/16"	E38	4V473H
RIC7783	32mm	1 1/4"	E40	4V474H



BI-HEX SOCKETS - 1/2" DRIVE - 50

- Stahlwille HPQ (high performance quality) sockets are manufactured from selected tough steel alloys
- Their extremely thin walls and unbelievably high load capacity are simply exemplary
- Stahlwille sockets are equipped with the AS Drive (anti slip drive) profile
- This permits high transmission of forces to lands of nuts and bolts without damaging them



Code	Size
STW03010008	8mm
STW03010009	9mm
STW03010010	10mm
STW03010011	11mm
STW03010013	13mm
STW03010014	14mm
STW03010015	15mm

Code	Size
STW03010016	16mm
STW03010017	17mm
STW03010018	18mm
STW03010020	20mm
STW03010021	21mm
STW03010022	22mm
STW03010023	23mm

Code	Size
STW03010024	24mm
STW03010025	25mm
STW03010026	26mm
STW03010027	27mm
STW03010028	28mm
STW03010030	30mm
STW03010032	32mm



BI-HEX SOCKETS - 1/2" DRIVE - 50A

- Stahlwille HPQ (high performance quality) sockets are manufactured from selected tough steel alloys
- Their extremely thin walls and unbelievably high load capacity are simply exemplary
- Stahlwille sockets are equipped with the AS Drive (anti slip drive) profile
- This permits high transmission of forces to lands of nuts and bolts without damaging them



Code	Size
STW03410024	3/8"
STW03410028	7/16"
STW03410032	1/2"

Code	Size
STW03410034	9/16"
STW03410035	19/32"
STW03410036	5/8"

Code	Size
STW03410038	11/16"
STW03410040	3/4"
STW03410044	7/8"



HEX SOCKETS - 1/2" DRIVE - 52

- Stahlwille HPQ (high performance quality) sockets are manufactured from selected tough steel alloys
- Their extremely thin walls and unbelievably high load capacity are simply exemplary
- Stahlwille sockets are equipped with the AS Drive (anti slip drive) profile
- This permits high transmission of forces to lands of nuts and bolts without damaging them



Code	Size
STW03030008	8mm
STW03030010	10mm
STW03030011	11mm
STW03030012	12mm
STW03030013	13mm

Code	Size
STW03030016	16mm
STW03030017	17mm
STW03030018	18mm
STW03030020	20mm
STW03030021	21mm

Code	Size
STW03030024	24mm
STW03030025	25mm
STW03030027	27mm
STW03030030	30mm
STW03030032	32mm
STW03030034	34mm

Automotive

115 1/2" Sockets

AVAILABLE FROM SELECTED DISTRIBUTORS NATIONWIDE



BI-HEX SOCKETS - 1/2" DRIVE - D19

- Manually operated sockets with thin walls and knurled base
- CHROME VANADIUM steel – 31CrV3
- Chrome plated and polished



Code	Size	Code	Size	Code	Size
GED613304	8mm	GED613460	22mm	GED613649	7/16"
GED613312	9mm	GED613479	23mm	GED613657	1/2"
GED613320	10mm	GED613487	24mm	GED613665	9/16"
GED613339	11mm	GED613495	25mm	GED613681	5/8"
GED613347	12mm	GED613509	26mm	GED613703	11/16"
GED613355	13mm	GED613517	27mm	GED613711	3/4"
GED613363	14mm	GED613525	28mm	GED613746	13/16"
GED613371	15mm	GED613533	29mm	GED613754	7/8"
GED613398	16mm	GED613541	30mm	GED613762	15/16"
GED613401	17mm	GED613576	32mm	GED613770	1"
GED613428	18mm	GED613584	33mm	GED613789	1 1/16"
GED613436	19mm	GED613568	36mm	GED613797	1 1/8"
GED613444	20mm	GED613606	5/16"	GED613819	1 1/4"
GED613452	21mm	GED613622	3/8"		

1/2"



C PROFILE SOCKETS - 1/2" DRIVE - C19

- Manually operated sockets with thin walls and knurled base
- CHROME VANADIUM steel – 31CrV3
- Chrome plated and polished



Code	Size	Code	Size
GED612006	8mm-5/16"	GED612154	20mm-25/32"
GED612014	9mm-11/32"	GED612162	21mm-13/16"
GED612022	10mm-3/8"	GED612170	22mm
GED612030	11mm	GED612189	23mm
GED612057	12mm	GED612197	24mm-15/16"
GED612065	13mm-1/2"	GED612200	25mm
GED612073	14mm	GED612219	26mm-1"
GED612081	15mm-19/32"	GED612227	27mm-1.1/16"
GED612103	16mm-5/8"	GED612235	28mm
GED612111	17mm	GED612243	29mm-1.1/8"
GED612138	18mm-11/16"	GED612251	30mm-1.3/16"
GED612146	19mm-3/4"	GED612278	32mm-1.1/4"



HEX SOCKETS - LONG 1/2" DRIVE

- Expert professional quality
- Manufactured to DIN3120 7 3124 specifications
- Chrome Vanadium steel, hardened and tempered.
- Chamfered ends allow for positive location and entry
- Satin chrome finish for maximum corrosion resistance



Code	Size	Ref.
RIC6890	10x76mm	RT4V/431
RIC6891	11x76mm	RT4V/432
RIC6892	12x76mm	RT4V/433
RIC6893	13x76mm	RT4V/434
RIC6894	14x76mm	RT4V/435
RIC6895	15x76mm	RT4V/436
RIC6896	16x76mm	RT4V/437
RIC6897	17x76mm	RT4V/438
RIC6898	18x76mm	RT4V/439
RIC6899	19x76mm	RT4V/440
RIC6990	20x76mm	RT4V/441
RIC6991	21x76mm	RT4V/442

Code	Size	Ref.
RIC6992	22x76mm	RT4V/443
RIC6993	24x76mm	RT4V/444
RIC6995	27x76mm	RT4V/445
RIC6998	30x76mm	RT4V/446
RIC7000	32x76mm	RT4V/447



BI-HEX LONG SOCKETS - 1/2" DRIVE - 51

- Stahlwille HPQ (high performance quality) sockets are manufactured from selected tough steel alloys
- Their extremely thin walls and unbelievably high load capacity are simply exemplary
- Stahlwille sockets are equipped with the AS Drive (anti slip drive) profile
- This permits high transmission of forces to lands of nuts and bolts without damaging them
- *With rubber insert for spark plugs



Code	Size	Code	Size	Code	Size
STW03020010	10mm	STW03020018	18mm	STW03020027	27mm
STW03020013	13mm	STW03020019	19mm	STW03020028	28mm
STW03020014	14mm	STW03020021	21mm	STW03020030	30mm
STW03020015	15mm	STW03020022	22mm	STW03020032	32mm
STW03020016	16mm	STW03020024	24mm	STW03020208	20.8mm*
STW03020017	17mm	STW03020026	26 mm		

Automotive

1/2"

GEDORE BI-HEX SOCKETS - DEEP 1/2" DRIVE - D19L

- Manually operate sockets with thin walls and knurled base
- CHROME VANADIUM steel -31CrV3
- Chrome plated and polished
- Length 82mm



Code	Size
GED015705	10mm
GED015706	12mm

GEDORE HEX SOCKETS - DEEP - 1/2" DRIVE - 19L

- Manually operated sockets with thin walls and knurled bases
- CHROME VANADIUM steel – 31CrV3
- Chrome plated and polished



Code	Size	Length
GED614017	13mm	77mm
GED614025	14mm	77mm
GED614033	17mm	77mm
GED614041	19mm	82mm
GED614068	21mm	82mm
GED614076	24mm	82mm
GED614130	1/2"	77mm
GED614149	9/16"	77mm
GED614157	5/8"	77mm
GED614165	11/16"	77mm

Code	Size	Length	Code	Size	Length
GED614173	3/4"	82mm	GED614203	7/8"	82mm
GED614181	13/16"	82mm	GED614211	15/16"	82mm



RACO SPARK PLUG SOCKETS - 1/2" DRIVE

- With flank drive
- Manufactured to high quality standards from chrome vanadium steel hardened and tempered for maximum strength
- Professional look two colour satin chrome finish
- Fitted with rubber plug protection insert



Code	Size	Ref.
RIC7630	16mm	6V503B
RIC7632	21mm	6V504B

GEDORE SPARK PLUG SOCKETS - 1/2" DRIVE

- CHROME VANADIUM steel 31CrV3
- Chrome plated
- To be used in conjunction with 1/2" drive accessories



Code	Size	Ref
GED636614	20.8mm - 13/16"	50
GED636622	16mm	54



RACO DIESEL INJECTOR SOCKET - 1/2" DRIVE

- For Diesel injectors
- Expert professional quality
- Manufactured to DIN3120 & 3124
- Chrome Vanadium steel, hardened and tempered with
- Thin wall
- 4 equally spaced lugs around the tip
- Satin chrome finish



Code	Length	Ref.
RIC7003	73mm	RT5V/485T



STABILWILLE SOCKET 4-PIN - 1/2" DRIVE - 3678

- For use on pressure nut of injector post
- Mercedes-Benz



Code	Size
STW03810001	72mm



RACO SPLINE SOCKETS - 1/2" DRIVE

- Expert professional quality socket
- Manufactured to DIN 3120 specifications
- Manufactured from Chrome vanadium steel with high quality S2 screwdriver head
- Correctly hardened and tempered and precision machined to deliver maximum turning power
- Satin chrome plated for corrosion protection



Code	Size	Ref.
RIC7925	M6 x 55mm	5V195
RIC7926	M8 x 55mm	5V196
RIC7928	M10 x 55mm	5V197
RIC7931	M6 x 100mm	5V203
RIC7932	M8 x 100mm	5V204
RIC7934	M10 x 100mm	5V205
RIC7936	M12 x 100mm	5V206



STABILWILLE SCREWDRIVER SOCKETS - 1/2" DRIVE - 54CV

- For spline socket head screws (RIBE CV)
- Chrome Alloy Steel
- Chrome plated
- All length 22mm except STW03090013 20mm



Code	Size	Code	Size	Code	Size
STW03090005	M5	STW03090008	M8	STW03090010	M10
STW03090007	M7	STW03090009	M9	STW03090013	M13

Automotive

117 1/2" Sockets

AVAILABLE FROM SELECTED DISTRIBUTORS NATIONWIDE



ALLEN KEY SOCKETS - 1/2" DRIVE

1/2"

- Expert professional quality socket
- Manufactured to DIN 3120 specifications
- Manufactured from Chrome vanadium steel with high quality S2 screwdriver head
- Correctly hardened and tempered and precision machined to deliver maximum turning power
- Satin chrome plated for corrosion protection



Code	Size	Ref.
RIC7566	5 x 55mm	5V091
RIC7567	6 x 55mm	5V092
RIC7568	7 x 55mm	5V093
RIC7569	8 x 55mm	5V094
RIC7571	10 x 55mm	5V096
RIC7573	12 x 55mm	5V097
RIC7575	14 x 55mm	5V098
RIC7578	17 x 55mm	5V099



INHEX SOCKETS - 1/2" DRIVE - 54

- For hexagon socket head screws
- DIN 7422
- Chrome Alloy Steel
- Chrome plated



Code	Size	Code	Size	Code	Size
STW03050004	4mm	STW03050010	10mm	STW03050017	17mm
STW03050007	7mm	STW03050012	12mm	STW03050019	19mm
STW03050008	8mm	STW03050014	14mm		



INHEX SOCKETS - 1/2" DRIVE - 54A

- For hexagon socket head screws
- DIN 7422
- Chrome Alloy Steel
- Chrome plated



Code	Size	Code	Size
STW03450024	3/8"	STW03450034	9/16"
STW03450028	7/16"		



HEXAGON BIT SOCKETS - 1/2" DRIVE - IN19

- For hexagon head screws
- Manually operated sockets with knurled base
- Sockets - CHROME VANADIUM steel – 31CRV3
- Bits – CHROME VANADIUM steel – 59CrV4



Code	Size	Length	Code	Size	Length
GED615315	5mm	60mm	GED615471	3/16"	60mm
GED615323	6mm	60mm	GED615498	7/32"	60mm
GED615331	7mm	60mm	GED615501	1/4"	60mm
GED615358	8mm	60mm	GED615528	9/32"	60mm
GED615366	9mm	60mm	GED615536	5/16"	60mm
GED615374	10mm	60mm	GED615544	3/8"	60mm
GED615382	12mm	60mm	GED615552	1/2"	60mm
GED615390	14mm	60mm	GED615560	9/16"	60mm
GED615404	17mm	60mm	GED615579	5/8"	60mm
GED615412	19mm	60mm			



ALLEN KEY SOCKETS - LONG - 1/2" DRIVE

- Expert professional quality socket
- Manufactured to DIN 3120 specifications
- Manufactured from Chrome vanadium steel with high quality S2 screwdriver head
- Correctly hardened and tempered and precision machined to deliver maximum turning power
- Satin chrome plated for corrosion protection



Code	Size	Ref.	Code	Size	Ref.
RIC7488	4 x 100mm	5V100	RIC7494	10 x 100mm	5V106
RIC7489	5 x 100mm	5V101	RIC7495	12 x 100mm	5V107
RIC7490	6 x 100mm	5V102	RIC7496	14 x 100mm	5V108
RIC7491	7 x 100mm	5V103	RIC7497	17 x 100mm	5V109
RIC7492	8 x 100mm	5V104	RIC7498	19 x 100mm	5V110
RIC7493	9 x 100mm	5V105			



HEXAGON BIT SOCKETS - EXTRA LONG 1/2" DRIVE - IN19L

- For hexagon head screws
- Manually operated sockets with knurled base
- Sockets - CHROME VANADIUM steel - 31CRV3
- Bits - CHROME VANADIUM steel - 59CrV4



Code	Size	Length
GED615730	6mm	100mm
GED615773	8mm	100mm
GED615811	10mm	100mm
GED615846	12mm	100mm
GED615862	14mm	100mm

Automotive

1/2" Sockets 120

1/2"



ADAPTORS - 1/2" DRIVE

- Heavy duty industrial quality to meet rigid specifications for mechanics industrial workers who need strength, speed and safety



- on tough jobs
- Hot forged and precision machined from high strength chrome vanadium steel
- Correctly hardened and tempered
- Chrome plated
- Square drive fitted with spring loaded locking ball for securely attaching accessories
- Satin chrome plated for corrosion protection

Code	Size	Ref.
RIC7540	1/2"F x 3/8"M	5V475
RIC7545	1/2"F x 3/4"M	5V545



REDUCER (ADAPTOR) - 1/2" DRIVE

- DIN 3123/ISO 3316
- HPQ High performance steel
- Chrome plated
- 1/2" socket x 3/4" plug (12.5 x 20)
- 1/2" socket x 3/8" plug (12.5 x 10)



Code	Ref	Length
STW13030002	513	35mm
STW13030005	514	44mm



CONVERTER (REDUCER) - 1/2" DRIVE 1932

- 1/2" female to 3/4" male
- For manually operated sockets and accessories with 1/2" drive
- CHROME VANADIUM steel – 31CrV3



Code	Length
GED614319	45mm



RATCHET ADAPTOR - 1/2" DRIVE

- Reversible
- 20 teeth



Code	Ref	Length
STW13140000	522	67.5mm



UNIVERSAL JOINT - 1/2" DRIVE

- Manufactured to DIN3122 & 3123
- Manufactured from chrome vanadium steel
- Correctly hardened and tempered for maximum strength and durability
- Square drive incorporates spring loaded retaining ball for secure socket holding
- Satin chrome plated for corrosion protection



Code	Size	Ref.
RIC7984	1/2" x 72mm	5V473



UNIVERSAL JOINT 1/2" DRIVE

- DIN 3123/ISO 3316
- Chrome alloy steel
- Chrome plated



Code	Ref	Length
STW13020000	510	71mm



UNIVERSAL JOINT - 1/2" DRIVE - 1995

- For manually operated sockets and accessories with 1/2" drive
- CHROME VANADIUM steel – 31CrV3



Code	Length
GED614475	70mm



COUPLER - SQUARE WITH MUSHROOM HEAD - 1/2" DRIVE - 1994

- For manually operated sockets and accessories with 1/2" drive
- CHROME VANADIUM steel – 31CrV3



Code	Length
GED614467	46mm

Automotive



EXTENSION BARS - 1/2" DRIVE 5V453

- Manufactured to DIN3122 & 3123
- Manufactured from chrome vanadium steel
- Correctly hardened and tempered for maximum strength and durability
- Square drive incorporates spring loaded retaining ball for secure socket holding
- Satin chrome plated for corrosion protection



Code	Size	Ref.
RIC7420	1/2" x 125mm	5V453
RIC7425	1/2" x 250mm	5V454



EXTENSION - 1/2" DRIVE

1/2"

- Manufactured to DIN 3123/ISO 3316
- Forged from Finest quality steel



Code	Ref	Length
STW13010001	509/2	52mm
STW13010002	509/5	130mm
STW13010003	509/10	255mm
STW13010004	509	75mm



EXTENSION BARS - 1/2" DRIVE - 1990

- For manually operated sockets and accessories with 1/2" drive
- CHROME VANADIUM steel – 31CrV3



Code	Length
GED614378	75mm
GED614386	125mm
GED614289	175mm
GED614394	250mm



SLIDING T-BAR - 1/2" DRIVE

- Manufactured to DIN3122 & DIN3123
- Manufactured from chrome vanadium steel
- Correctly hardened and tempered for maximum strength and durability
- Square drive incorporates spring loaded retaining ball for secure socket holding
- Satin chrome plated for corrosion protection



Code	Size	Ref.
RIC7960	1/2" x 250mm	5V451



SLIDING T HANDLE - 1/2" DRIVE - 1987

- For manually operated sockets and accessories with 1/2" drive
- CHROME VANADIUM steel – 31CrV3



Code	Length
GED614343	290mm



SPEEDBRACE - 1/2" DRIVE

Code	Size	Ref.
RIC7635	1/2"Dr x 400mm	6V505



- Manufactured to DIN3122 & 3123
- Manufactured from chrome vanadium steel
- Correctly hardened and tempered for maximum strength and durability
- Square drive incorporates spring loaded retaining ball for secure socket holding
- Satin chrome plated for corrosion protection
- Plastic handle swivels so brace can be rotated



SPEEDBRACE HANDLE- 1/2" DRIVE - 1985

- For manually operated sockets and accessories with 1/2" drive
- CHROME VANADIUM steel - 31CrV3

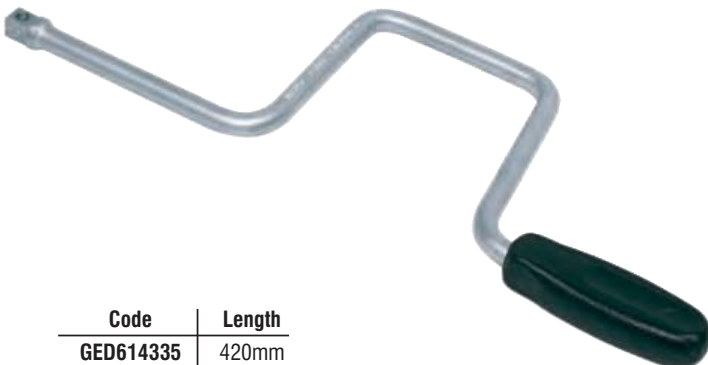

Code	Length
GED614335	420mm



RATCHET REVERSIBLE- 72 TEETH - 1/2" DRIVE

- High torque, manufactured to DIN 3122 specification
- Dropped forged from one piece chrome vanadium steel
- Heat treated to obtain maximum hardness and precision machined for rugged strength and dependability
- Reversible 72 teeth heavy duty ratchet mechanism with quick release and quick changeover lever
- Satin finish



Code	Size	Ref.
RIC7510	1/2" Dr x 260mm	5V493

Automotive

1/2"



RATCHET - PUSH THROUGH 1/2" DRIVE (72 TEETH)

- High torque, manufactured to **DIN 3122** specification
- Dropped forged from one piece chrome vanadium steel
- Heat treated to obtain maximum hardness and precision
- machined for rugged strength and dependability
- Push through square to reverse direction
- Satin finish



Code	Size	Ref.
RIC7511	1/2" Dr x 270mm	5V495H

Repair kits are available



RATCHET - 1/2" DRIVE

- DIN 3122/ISO 3315 specification
- Manufactured from chrome alloy steel
- Chrome plated
- Reversible, 36 teeth
- With 2 - component handle



Code	Ref	Length
STW13111010	512	265.5mm



RATCHET - REVERSIBLE - 1/2" DRIVE WITH RECESSED LEVER - 1993 U-10T

- Quick release button
- For manually operated sockets and accessories with 1/2" square drive
- CHROME VANADIUM steel - 31CrV3
- 11° ratchet arch



Code	Length
GED614262	270mm



RATCHET - REVERSIBLE - 1/2" DRIVE 1993 U-3

- For manually operated sockets and accessories with 1/2" drive
- CHROME VANADIUM steel - 31CrV3
- 7° ratchet arch



Code	Length
GED614416	270mm



RATCHET - REVERSIBLE - 1/2" DRIVE 1993Z/94

- For manually operated sockets and accessories with 1/2" drive
- CHROME VANADIUM steel - 31CrV3
- 15° ratchet arch



Code	Length
GED614459	270mm



POWER BAR - 1/2" DRIVE

- Manufactured from Chrome Vanadium steel, hardened and tempered for maximum strength and durability
- Square drive incorporates spring loaded retaining ball for securing sockets
- Manufactured to **DIN3122 & 3123**



Code	Size	Ref.
RIC7475	1/2" x 375mm	5V471

Repair kits are available



POWERBAR (FLEXIBLE HANDLE) 1/2" DRIVE

- Manufactured to DIN 3122/ISO 3315
- Forged from Finest quality steel
- With 2 - component handle



Code	Ref	Length
STW13061012	504/15	397mm
STW13061013	504/18	469mm



POWER BAR - 1/2" DRIVE - 1996 & 1997

- For manually operated sockets and accessories with 1/2" drive
- CHROME VANADIUM steel - 31CrV3



Code	Length
GED614483	250mm
GED614491	375mm
GED614556	450mm

Automotive



BI-HEX SOCKET - 3/4" DRIVE



- Manufactured from hot forged high strength chrome vanadium steel
- Precision machined, special heat treating imparts great strength and toughness
- Chrome plated finish for long service life
- Precision chamfered ends of socket opening and square drive to provide accurate fit and nut location

3/4"

Code	Size	Ref.	Code	Size	Ref.	Code	Size	Ref.
RIC7822	22mm	5V633	RIC7832	32mm	5V640	RIC7841	41mm	5V644
RIC7824	24mm	5V635	RIC7836	36mm	5V642	RIC7846	46mm	5V645
RIC7827	27mm	5V637	RIC7838	38mm	5V643	RIC7850	50mm	5V646
RIC7830	30mm	5V639						



HEX SOCKET - 3/4" DRIVE - 55

- Sockets are manufactured from selected tough steel alloys
- Their extremely thin walls and unbelievably high load capacity are simply exemplary
- Stahlwille sockets are equipped with the AS Drive (anti slip drive) profile
- This permits high transmission of forces to lands of nuts and bolts without damaging them



Code	Size	Code	Size	Code	Size
STW05010019	19mm	STW05010030	30mm	STW05010041	41mm
STW05010020	20mm	STW05010032	32mm	STW05010046	46mm
STW05010021	21mm	STW05010033	33mm	STW05010050	50mm
STW05010022	22mm	STW05010034	34mm	STW05010055	55mm
STW05010024	24mm	STW05010036	36mm	STW05010060	60mm
STW05010027	27mm	STW05010038	38mm		



C-PROFILE SOCKET - 3/4" DRIVE - C32

- Manually operated sockets with thin walls and knurled base
- CHROME VANADIUM steel- 31CrV3
- Chrome plated



Code	Size	Code	Size
GED626007	19mm-3/4"	GED626104	33mm-1 5/16"
GED626015	22mm-7/8"	GED626112	34mm
GED626023	24mm-15/16"	GED626171	36mm-1 7/16"
GED626058	26mm-1"	GED626201	38mm-1 1/2"
GED626066	27mm-1 1/16"	GED626228	41mm-1 5/8"
GED626082	30mm-1 3/16"	GED626244	46mm- 1 13/16"
GED626090	32mm-1 1/4"		



BI-HEX PROFILE SOCKET - 3/4" DRIVE - D32

- Manually operated sockets with thin walls and knurled base
- CHROME VANADIUM steel- 31CrV3
- Chrome plated



Code	Size	Code	Size
GED627216	19mm	GED627402	7/8"
GED627224	22mm	GED627410	15/16"
GED627232	24mm	GED627429	1"
GED627240	27mm	GED627445	1 1/8"
GED627259	29mm	GED627453	1 1/4"
GED627267	30mm	GED627461	1 5/16"
GED627275	32mm	GED627488	1 3/8"
GED627704	33mm	GED627496	1 7/16"
GED627763	34mm	GED627534	1/11/16"
GED627283	36mm	GED627569	1 7/8"
GED627291	38mm	GED627577	2"
GED627305	41mm		
GED627313	46mm		
GED627321	50mm		



HEX SOCKET DEEP - 3/4" DRIVE - 56

- Stahlwille HPQ (high performance quality) sockets are manufactured from selected tough steel alloys
- Their extremely thin walls and unbelievably high load capacity are simply exemplary
- Stahlwille sockets are equipped with the AS Drive (anti slip drive) profile
- This permits high transmission of forces to lands of nuts and bolts without damaging them



Code	Size	Code	Size
STW05020024	24mm	STW05020034	34mm
STW05020027	27mm	STW05020036	36mm
STW05020030	30mm	STW05020041	41mm
STW05020032	32mm		

3/4"



INHEX SOCKET - 3/4" DRIVE 59

- For socket head screws
- DIN 7422
- Chrome Alloy Steel

Code	Size
STW05050014	14mm
STW05050017	17mm
STW05050019	19mm
STW05050022	22mm



ADAPTOR - 3/4" DRIVE

- Heavy duty industrial quality to meet rigid specifications for mechanics
- industrial workers who need strength, speed and safety on tough jobs
- Hot forged and precision machined from high strength chrome vanadium steel
- Correctly hardened and tempered
- Chrome plated
- Square drive fitted with spring loaded locking ball for securely attaching accessories
- Satin chrome plated for corrosion protection

Code	Size	Ref.
RIC7550	3/4"F x 1/2"M	5V686
RIC7555	3/4"F x 1"M	5V762



REDUCER (ADAPTOR) - 3/4" DRIVE

- DIN 3123ISO 3316
- HPQ High performance steel
- Chrome plated
- 3/4" socket x 1/2" plug (20 x 12.5)
- Maximum torque 512Nm



Code	Ref	Length
STW15030003	568	55mm



REDUCER (ADAPTOR) - 3/4" DRIVE

- DIN 3123ISO 3316
- HPQ High performance steel
- Chrome plated
- 3/4" inside x 1" plug (20 x 25)



Code	Ref	Length
STW15030006	569	61mm



CONVERTER (REDUCER) - 3/4" DRIVE 3221

- For manually operated sockets and accessories with 3/4" drive
- CHROME VANADIUM steel- 31CrV3
- 3/4" Female to 1" Male



Code	Length
GED627828	61mm



UNIVERSAL JOINT - 3/4" DRIVE

- Heavy duty industrial quality to meet rigid specifications for mechanics, industrial workers who need strength, speed and safety on tough jobs
- Hot forged and precision machined from high strength chrome vanadium steel
- Correctly hardened and tempered
- Chrome plated
- Square drive fitted with spring loaded locking ball for securely attaching accessories

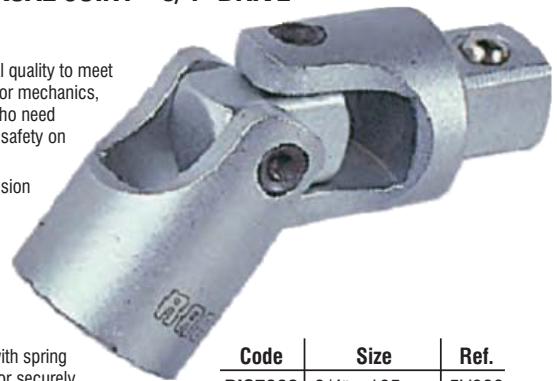

Code	Size	Ref.
RIC7986	3/4" x 105mm	5V688



UNIVERSAL JOINT 3/4" DRIVE

- DIN 3123/ISO 3316
- Chrome alloy steel
- Chrome plated



Code	Ref	Length
STW15020000	561	109mm



SQUARE COUPLER - 3/4" DRIVE - 3294

- For manually operated sockets and accessories with 3/4" drive
- CHROME VANADIUM steel- 59CrV4



Code	Length
GED627909	51.5mm

Automotive



EXTENSION BARS - 3/4" DRIVE

- Heavy duty industrial quality to meet rigid specifications for mechanics, industrial workers who need strength, speed and safety on tough jobs
- Hot forged and precision machined from high strength chrome vanadium steel

- Correctly hardened and tempered
- Chrome plated
- Square drive fitted with spring loaded locking ball for securely attaching accessories

3/4"

Code	Size	Size
RIC7430	3/4" x 100mm	5V681
RIC7435	3/4" x 200mm	5V682



EXTENSION - 3/4" DRIVE

- Manufactured to DIN 3123/ISO 3316
- Forged from Finest quality steel



Code	Ref	Length
STW15010003	559/4	95mm
STW15010001	559/8	200mm
STW15010002	559/16	400mm



EXTENSION BAR - 3/4" DRIVE - 3290

- For manually operated sockets and accessories with 3/4" drive
- CHROME VANADIUM steel- 31CrV3



Code	Length
GED627844	200mm
GED627852	400mm



SLIDING T-BAR - 3/4" DRIVE

- Heavy duty industrial quality to meet rigid specifications for mechanics, industrial workers who need strength, speed and safety on tough jobs
- Hot forged and precision machined from high strength chrome vanadium steel
- Correctly hardened and tempered

- Chrome plated
- Square drive fitted with spring loaded locking ball for securely attaching accessories



Code	Size	Size
RIC7965	3/4" x 450mm	5V677



SLIDING T BAR - 3/4" DRIVE - 3287

- For manually operated sockets and accessories with 3/4" drive
- CHROME VANADIUM steel- 31CrV3



Code	Length
GED627836	500mm



RATCHET - REVERSIBLE - 3/4" DRIVE

- Heavy duty industrial quality to meet rigid specifications for mechanics, industrial workers who need strength, speed and safety on tough jobs
- Hot forged and precision machined from high strength chrome vanadium steel
- Correctly hardened and tempered
- Chrome plated
- Square drive fitted with spring loaded locking ball for securely attaching accessories

- Sturdy construction for tough nut turning jobs, with quick changeover lever for forward and reverse operations
- Detachable handle with knurled anti slip grip
- Strong ratchet specially made from chrome vanadium/molybdenum steel and working parts are precision machined, heat treated for smooth action and long life



Code	Size	Ref.
RIC7515	3/4"Dr x 500mm	5V670

Repair kits are available

3/4"



RATCHET - REVERSIBLE WITH LEVER CONTROL - 3/4" DRIVE - 3293 U-1

- For manually operated sockets and accessories with 3/4" drive
- CHROME VANADIUM steel- 31CrV3
- Detachable handle
- 15° Ratchet arch



Code	Length
GED627798	500mm



RATCHET - DOUBLE JOHNNY - 3/4" DRIVE - 3293/500DJ

- Double 3/4" drive coupler
- 500mm detachable handle
- For manually operated sockets and accessories with 3/4" drive
- CHROME VANADIUM steel- 31CrV3



Code
GED627127



RATCHET - REVERSIBLE WITH DISC CHANGE - 3/4" DRIVE - 3293 U-2

- For manually operated sockets and accessories with 3/4" drive
- CHROME VANADIUM steel- 31CrV3
- Detachable handle
- 7° Ratchet arch



Code	Length
GED627860	500mm



RATCHET - REVERSIBLE WITH PUSH THROUGH COUPLER - 3/4" DRIVE - 3293 Z/94

- For manually operated sockets and accessories with 3/4" drive
- CHROME VANADIUM steel- 31CrV3
- Detachable handle
- 10° Ratchet arch



Code	Length
GED627895	500mm

Automotive

127 3/4" Ratchets

AVAILABLE FROM SELECTED DISTRIBUTORS NATIONWIDE



POWER BAR - 3/4" DRIVE

- Heavy duty industrial quality to meet rigid specifications for mechanics, industrial workers who need strength, speed and safety on tough jobs
- Hot forged and precision machined from high strength chrome vanadium steel
- Correctly hardened and tempered
- Chrome plated
- Square drive fitted with spring loaded locking ball for securely attaching accessories
- Head swivels to any position and an inner spring holds it in semi flex condition
- Knurled handle

3/4"



	Code	Size	Ref.
Repair kits are available	RIC7480	3/4" x 500mm	5V675



POWER BAR- 3/4" DRIVE - 3296

- For manually operated sockets and accessories with 3/4" drive
- CHROME VANADIUM steel- 31CrV3



Code	Length
GED627925	543mm



RATCHET BAR HANDLE FOR 3/4" DRIVE

- Manufactured from Chrome Alloy Steel
- Chrome plated



Code	Ref	Length
STW15170000	558	510mm



POWER HEAD (FLEXIBLE HEAD) - 3/4" DRIVE

- Chrome alloy steel
- Chrome plated
- Without bar handle 558



Code	Ref	Length
STW15060000	554	131mm



SLIDING HEAD - 3/4" DRIVE

- Chrome alloy steel
- Chrome plated
- Without Bar Handle 558



Code	Ref	Length
STW15070000	556	61.5mm



RATCHET HEAD - 3/4" DRIVE

- Manufactured from Chrome Alloy Steel
- Chrome plated
- Reversible, 36 teeth with quick release safety lock
- Without bar 558



Code	Ref	Length
STW15110000	552	165mm

1"



BI-HEX SOCKETS 1" DRIVE



- Manufactured from hot forged high strength chrome vanadium steel
- Precision machined, special heat treating imparts great strength and toughness
- Chrome plated finish for long service life
- Precision chamfered ends of socket opening and square drive to provide accurate fit and nut location



Code	Size	Ref.
RIC7900	36mm	5V735
RIC7902	41mm	5V737
RIC7904	46mm	5V738

Code	Size	Ref.
RIC7906	50mm	5V739
RIC7908	55mm	5V741
RIC7910	60mm	5V732

Code	Size	Ref.
RIC7912	65mm	5V743
RIC7914	70mm	5V745
RIC7916	75mm	5V746
RIC7918	80mm	5V748



BI-HEX SOCKETS - 1" DRIVE - 60

- Stahlwille HPQ (high performance quality) sockets are manufactured from selected tough steel alloys
- Their extremely thin walls and unbelievably high load capacity are simply exemplary
- Stahlwille sockets are equipped with the AS Drive (anti slip drive) profile
- This permits high transmission of forces to lands of nuts and bolts without damaging them



Code	Size
STW06010030	30mm
STW06010032	32mm
STW06010034	34mm

Code	Size
STW06010036	36mm
STW06010041	41mm
STW06010046	46mm

Code	Size
STW06010050	50mm
STW06010055	55mm



HEX SOCKETS - 1" DRIVE - 60

- Socket made to DIN 3124
- Chrome alloy steel
- Chrome plated



Code	Size
STW06010065	65mm
STW06010070	70mm
STW06010075	75mm



INHEX SOCKETS - 1" DRIVE - 64

- DIN 7422
- Chrome Alloy Steel
- Chrome plated



Code	Size
STW06050017	17mm
STW06050019	19mm
STW06050022	22mm
STW06050024	24mm



ADAPTOR - 1" DRIVE

- Heavy duty industrial quality to meet rigid specifications for mechanics, industrial workers who need strength, speed and safety on tough jobs
- Hot forged and precision machined from high strength chrome vanadium steel
- Correctly hardened and tempered
- Chrome plated
- Square drive fitted with spring loaded locking ball for securely attaching accessories
- Satin chrome plated for corrosion protection



Code	Size	Ref.
RIC7560	1"F x 3/4"M	5V763



UNIVERSAL JOINT - 1" DRIVE

- Heavy duty industrial quality to meet rigid specifications for mechanics, industrial workers who need strength, speed and safety on tough jobs
- Hot forged and precision machined from high strength chrome vanadium steel
- Correctly hardened and tempered
- Chrome plated
- Square drive fitted with spring loaded locking ball for securely attaching accessories



Code	Size	Ref.
RIC7988	1"Dr x 143mm	5V765

Automotive



EXTENSION BARS - 1" DRIVE

- Heavy duty industrial quality to meet rigid specifications for mechanics, industrial workers who need strength, speed and safety on tough jobs
- Hot forged and precision machined from high strength chrome vanadium steel
- Correctly hardened and tempered
- Chrome plated
- Square drive fitted with spring loaded locking ball for securely attaching accessories

Code	Size	Ref.
RIC7440	1" x 200mm	5V758
RIC7445	1" x 400mm	5V759



EXTENSIONS 1" DRIVE

- Manufactured to DIN 3123/ISO 3316
- Forged from Finest quality steel

Code	Ref	Length
STW16010001	859/8	200mm
STW16010002	859/16	410mm



SLIDING T-BAR - 1" DRIVE

- Heavy duty industrial quality to meet rigid specifications for mechanics, industrial workers who need strength, speed and safety on tough jobs
- Hot forged and precision machined from high strength chrome vanadium steel
- Correctly hardened and tempered
- Chrome plated
- Square drive fitted with spring loaded locking ball for securely attaching accessories



Code	Size	Ref.
RIC7970	1"Dr x 550mm	5V755



RATCHET - REVERSIBLE - 1" DRIVE

- Heavy duty industrial quality to meet rigid specifications for mechanics, industrial workers who need strength, speed and safety on tough jobs
- Hot forged and precision machined from high strength chrome vanadium steel
- Correctly hardened and tempered
- Chrome plated
- Square drive fitted with spring loaded locking ball for securely attaching accessories
- Sturdy construction for tough nut turning jobs, with quick changeover lever for forward and reverse operations
- Detachable handle with knurled anti slip grip
- Strong ratchet specially made from chrome vanadium/molybdenum steel and working parts are precision machined, heat treated for smooth action and long life



Code	Size	Ref.
RIC7520	1"Dr x 650mm	5V751

Repair kits are available



POWER BAR - 1" DRIVE

- Heavy duty industrial quality to meet rigid specifications for mechanics industrial workers who need strength, speed and safety on tough jobs
- Hot forged and precision machined from high strength chrome vanadium steel
- Correctly hardened and tempered
- Chrome plated
- Square drive fitted with spring loaded locking ball for securely attaching accessories
- Head swivels to any position and an inner spring holds it in semi flex condition
- Knurled handle



Code	Size	Ref.
RIC7485	1"Dr x 650mm	5V753

Repair kits are available



RATCHET BAR HANDLE FOR 1" DRIVE

- Manufactured from Chrome Alloy Steel
- Chrome plated



Code	Ref	Length
STW16170000	888	700mm

1"



POWER HEAD (FLEXIBLE HEAD) 1" DRIVE

- Chrome alloy steel
- Chrome plated
- Without bar handle 888



Code	Ref	Length
STW16060000	884	195mm



SLIDING HEAD - 1" DRIVE

- Chrome alloy steel
- Chrome plated
- Without Bar Handle 888



Code	Ref	Length
STW16070000	886	80mm



RATCHET HEAD - 1" DRIVE

- Manufactured from Chrome Alloy Steel
- Chrome plated
- Reversible, 36 teeth
- Without bar handle 888



Code	Ref	Length
STW16110000	882	185mm



Automotive

BRITO HEX IMPACT SOCKETS - 1/2" DRIVE

- Brito impact sockets are made from best grade chrome vanadium steel
- They are hardened and heat treated to ensure that they are normalized and non-warping
- They are extremely accurately made with very close tolerances
- Ideal for use with heavy duty air wrenches



Code	Size	Code	Size
BRI3010	10mm	BRI3021	21mm
BRI3011	11mm	BRI3022	22mm
BRI3012	12mm	BRI3023	23mm
BRI3013	13mm	BRI3024	24mm
BRI3014	14mm	BRI3025	25mm
BRI3015	15mm	BRI3026	26mm
BRI3016	16mm	BRI3027	27mm
BRI3017	17mm	BRI3028	28mm
BRI3018	18mm	BRI3029	29mm
BRI3019	19mm	BRI3030	30mm
BRI3020	20mm	BRI3032	32mm

1/2"

BRITO BI-HEX IMPACT SOCKETS - 1/2" DRIVE

- Brito impact sockets are made from best grade chrome vanadium steel
- They are hardened and heat treated to ensure that they are normalized and non-warping
- They are extremely accurately made with very close tolerances
- Ideal for use with heavy duty air wrenches



Code	Size
BRI7000	17mm
BRI7002	19mm

BRITO HEX IMPACT SOCKETS - LONG SERIES 1/2" DRIVE

- Brito impact sockets are made from best grade chrome vanadium steel
- They are hardened and heat treated to ensure that they are normalized and non-warping
- They are extremely accurately made with very close tolerances
- Ideal for use with heavy duty air wrenches



Code	Size	Code	Size
BRI7010	10mm	BRI7021	21mm
BRI7012	12mm	BRI7024	24mm
BRI7013	13mm	BRI7025	25mm
BRI7014	14mm	BRI7027	27mm
BRI7017	17mm	BRI7028	28mm
BRI7018	18mm	BRI7030	30mm
BRI7019	19mm	BRI7032	32mm

BRITO BI-HEX IMPACT SOCKETS - LONG SERIES 1/2" DRIVE

- Brito impact sockets are made from best grade chrome vanadium steel
- They are hardened and heat treated to ensure that they are normalized and non-warping
- They are extremely accurately made with very close tolerances
- Ideal for use with heavy duty air wrenches



Code	Size
BRI7004	17mm
BRI7006	19mm

BRITO INJECTOR SOCKET - 1/2" DRIVE

- Used on injectors
- 4 pin impact injector socket
- Heavy duty application high quality steel



Code
BRI2800

BRITO IMPACT REDUCERS 1/2" DRIVE

- Manufactured for use with impact sockets
- Heavy duty application high quality steel



Code	Size
BRI0029	1/2"F - 3/8"M
BRI0030	1/2"F - 3/4"M

STAHN WILLE UNIVERSAL JOINT 1/2" DRIVE

- DIN 3123/ISO 3316
- Chrome alloy steel
- Chrome plated
- Length 68mm



Code	Ref
STW33020000	510IMP

BRITO IMPACT EXTENSIONS 1/2" DRIVE

- Used for extending the reach of the socket
- Specially manufactured for use with impact sockets
- High quality steel



Code	Size
BRI0010	125mm
BRI0012	250mm

Automotive

3/4"

BRITO HEX IMPACT SOCKETS - 3/4" DRIVE

- Brito impact sockets are made from best grade chrome vanadium steel
- They are hardened and heat treated to ensure that they are normalized and non-warping
- They are extremely accurately made with very close tolerances
- Ideal for use with heavy duty air wrenches



Code	Size	Code	Size	Code	Size
BRI5017	17mm	BRI5027	27mm	BRI5037	37mm
BRI5018	18mm	BRI5028	28mm	BRI5040	40mm
BRI5019	19mm	BRI5029	29mm	BRI5042	42mm
BRI5020	20mm	BRI5030	30mm	BRI5046	46mm
BRI5021	21mm	BRI5032	32mm	BRI5048	48mm
BRI5022	22mm	BRI5033	33mm	BRI5050	50mm
BRI5023	23mm	BRI5034	34mm	BRI5052	52mm
BRI5024	24mm	BRI5035	35mm	BRI5060	60mm
BRI5026	26mm	BRI5036	36mm		

BRITO BI-HEX IMPACT SOCKETS - 3/4" DRIVE

- Brito impact sockets are made from best grade chrome vanadium steel
- They are hardened and heat treated to ensure that they are normalized and non-warping
- They are extremely accurately made with very close tolerances
- Ideal for use with heavy duty air wrenches



Code	Size
BRI7008	17mm
BRI7009	19mm

BRITO HEX IMPACT SOCKETS - WHEEL NUT - 3/4" DRIVE

- Specially designed for use on square section wheel nuts
- Brito impact sockets are made from best grade chrome vanadium steel
- They are hardened and heat treated to ensure that they are normalized and non-warping
- They are extremely accurately made with very close tolerances
- Ideal for use with heavy duty air wrenches



Code	Size
BRI9087	17mm
BRI9088	21mm
BRI9095	27mm

BRITO HEX IMPACT SOCKETS - LONG SERIES 3/4" DRIVE

- Brito impact sockets are made from best grade chrome vanadium steel
- They are hardened and heat treated to ensure that they are normalized and non-warping
- They are extremely accurately made with very close tolerances
- Ideal for use with heavy duty air wrenches



Code	Size	Code	Size
BRI8018	18mm	BRI8038	38mm
BRI8019	19mm	BRI8041	41mm
BRI8021	21mm	BRI8046	46mm
BRI8022	22mm	BRI8048	48mm
BRI8027	27mm	BRI8050	50mm
BRI8030	30mm	BRI8055	55mm
BRI8033	33mm		

BRITO IMPACT REDUCER - 3/4" Drive

- Allows 3/4" drive sockets to be used with 1" accessories
- Manufactured for use with impact sockets
- Heavy duty application high quality steel



Code	Size
BRI0032	3/4" F - 1" M



REDUCER (ADAPTOR) 3/4" DRIVE

- DIN 3123/ISO 3316
- HPQ High performance steel
- Chrome plated
- 3/4" socket x 1/2" plug (20 x 12.5)
- Maximum torque 512Nm



Code	Ref
STW35030003	568IMP



UNIVERSAL JOINT 3/4" DRIVE

- DIN 3123/ISO 3316
- Chrome alloy steel
- Chrome plated



Code	Ref
STW35020000	561IMP

BRITO UNIVERSAL - 3/4" DRIVE

- Brito impact sockets are made from best grade chrome vanadium steel
- They are hardened and heat treated to ensure that they are normalized and non-warping
- They are extremely accurately made with very close tolerances
- Ideal for use with Heavy duty Air Wrenches



Code
BRI9098

Automotive

BRITO IMPACT EXTENSIONS - 3/4" DRIVE

- Used for extending the reach of the socket
- Specially manufactured for use with impact sockets
- High quality steel



Code	Size
BRI0015	175mm
BRI0016	250mm
BRI0017	330mm

BRITO SLIDING T BAR - 3/4" DRIVE

- Used for loosening or tightening sockets
- Use where extra leverage is required
- Manufactured for use with impact sockets
- Heavy duty application high quality steel



Code
BRI0100

3/4"

BRITO HEX IMPACT SOCKETS - 1" DRIVE

- Brito impact sockets are made from best grade chrome vanadium steel
- They are hardened and heat treated to ensure that they are normalized and non-warping
- They are extremely accurately made with very close tolerances
- Ideal for use with heavy duty air wrenches



Code	Size
BRI6019	19mm
BRI6021	21mm
BRI6022	22mm
BRI6024	24mm
BRI6025	25mm
BRI6026	26mm
BRI6027	27mm
BRI6028	28mm
BRI6029	29mm
BRI6030	30mm
BRI6032	32mm

Code	Size
BRI6033	33mm
BRI6034	34mm
BRI6035	35mm
BRI6036	36mm
BRI6038	38mm
BRI6040	40mm
BRI6041	41mm
BRI6042	42mm
BRI6044	44mm
BRI6046	46mm

Code	Size
BRI6048	48mm
BRI6050	50mm
BRI6052	52mm
BRI6055	55mm
BRI6060	60mm
BRI6065	65mm
BRI6070	70mm
BRI6075	75mm
BRI6080	80mm
BRI6085	85mm

1"

BRITO HEX IMPACT SOCKETS - LONG SERIES 1" DRIVE

- Brito impact sockets are made from best grade chrome vanadium steel
- They are hardened and heat treated to ensure that they are normalized and non-warping
- They are extremely accurately made with very close tolerances
- Ideal for use with heavy duty air wrenches



Code	Size	Code	Size
BRI9024	24mm	BRI9046	46mm
BRI9027	27mm	BRI9050	50mm
BRI9030	30mm	BRI9055	55mm
BRI9033	33mm	BRI9060	60mm
BRI9036	36mm	BRI9070	70mm
BRI9038	38mm	BRI9075	75mm
BRI9041	41mm		

BRITO IMPACT REDUCER - 1" DRIVE

- Allows 1" drive sockets to be used with 3/4" accessories
- Manufactured for use with impact sockets
- Heavy duty application high quality steel



Code	Size
BRI0033	1"F - 3/4"M

STABIL WILLET UNIVERSAL JOINT - 1" DRIVE

- DIN 3123/ISO 3316
- Chrome alloy steel
- Chrome plated



Code	Ref
STW36020000	871IMP

BRITO UNIVERSAL - 1" DRIVE

- Brito impact sockets are made from best grade chrome vanadium steel
- They are hardened and heat treated to ensure that they are normalized and non-warping
- They are extremely accurately made with very close tolerances
- Ideal for use with Heavy duty Air Wrenches



Code	Size
BRI9099	1"

Automotive

1"

BRITO IMPACT EXTENSIONS - 1" DRIVE

- Used for extending the reach of the socket
- Specially manufactured for use with impact sockets
- High quality steel



Code	Size
BRI0020	175mm
BRI0021	250mm
BRI0022	330mm

BRITO SLIDING T BAR - 1" DRIVE

- Used for loosening or tightening sockets
- Use where extra leverage is required
- Manufactured for use with impact sockets
- Heavy duty application high quality steel



Code
BRI0110

Nut Drivers



NUT SPINNER (DRIVER) - 12500N

- DIN 3125
- Chrome Vanadium
- Chrome plated
- 2 component handle



Code	Size	Code	Size
STW43091004	4mm	STW43091008	8mm
STW43091045	4.5mm	STW43091009	9mm
STW43091005	5mm	STW43091010	10mm
STW43091055	5.5mm	STW43091011	11mm
STW43091006	6mm	STW43091012	12mm
STW43091007	7mm	STW43091013	13mm



NUT DRIVER - T HANDLE - 12507-2K

- DIN 3125
- Chrome Vanadium
- Matt chrome plated
- 2 component handle



Code	Size
STW43232080	8mm
STW43232100	10mm



NUT DRIVERS - 33

- For hexagon head screws, bolts and nuts
- Round blade with deep hexagon socket
- Made from high grade CHROME VANADIUM steel
- Chrome plated



Code	Size
GED36887	10mm
GED36888	11mm
GED36889	12mm
GED36890	13mm
GED36891	14mm



NUT DRIVERS - SET 10 - 33/10

- For hexagon head screws, bolts and nuts
- Round blade with deep hexagon socket
- Made from high grade CHROME VANADIUM steel
- Chrome plated
- Contents: 5.5, 6.0, 7.0, 8.0, 9.0, 10.0, 11.0, 12.0, 13.0, 14.0mm



Code
GED96670

Automotive

BUILT RACO TOUGH!



Raco socket sets are built tough. Even the case is engineered from high impact PVC to be completely resistant to rust and bending. Professional, industrial quality Raco socket sets are designed specifically for heavy duty work and meet DIN3120, DIN3122, DIN3123 & DIN 3124 specifications.

1/4"



SOCKET - HEX SET - 1/4" DRIVE PROFI-PLUS 19 PIECE - RT5/502

- Manufactured from chrome vanadium steel
- Hardened and tempered for maximum strength
- Socket ends chamfered to allow for positive location and entry
- Satin chrome finish for maximum corrosion protection
- Square drives incorporate spring-loaded retaining ball for secure socket holding
- Case engineered from high impact PVC to be completely resistant to rust and bending
- Contents:
 - 1/4" dr Hex sockets: 4, 4.5, 5, 5.5, 6, 7, 8, 9, 10, 11, 12, 13, 14mm
 - Ratchet handle
 - Extension bars: 50, 150mm
 - Universal joint
 - Spinner handle
 - Sliding T-bar

6 Point



DIN	DIN	DIN
3122	3123	3124

Part No.	Size
RIC3415	19 Piece



SOCKET - HEX SET - 1/4" DRIVE PROFI-PLUS 42 PIECE - RT5/504

- Manufactured from chrome vanadium steel
- Hardened and tempered for maximum strength
- Socket ends chamfered to allow for positive location and entry
- Satin chrome finish for maximum corrosion protection
- Square drives incorporate spring-loaded retaining ball for secure socket holding
- Case engineered from high impact PVC to be completely resistant to rust and bending

6 Point



- Contents:
 - 1/4" dr hex sockets: 3.2, 4, 4.5, 5, 5.5, 6, 7, 8, 9, 10, 11, 12, 13, 14mm
 - Ratchet handle: 145mm
 - Extension bars: 50, 150mm
 - Universal joint
 - Bit holder: 1/4"F x 1/4"F
 - Spinner handle
 - Adaptor for extension: 3/8"F x 1/4"M
 - Magnetic socket pick-up
 - 1/4" bit 25mm long
 - Flat: 4, 5.5, 6.5
 - Torx®: T10, T15, T20, T25, T30, T40
 - Socket allen key: 3, 4, 5, 6, 8
 - Phillips: No 1, No 2, No 3
 - Pozi driv: No 1, No 2, No 3



DIN	DIN	DIN
3122	3123	3124

Part No.	Size
RIC3416	42 Piece



SOCKET - HEX SET - 1/4" DRIVE PROFI-PLUS 42 PIECE - RT5/504

- Manufactured from chrome vanadium steel
- Hardened and tempered for maximum strength
- Socket ends chamfered to allow for positive location and entry
- Satin chrome finish for maximum corrosion protection
- Square drives incorporate spring-loaded retaining ball for secure socket holding
- Case engineered from high impact PVC to be completely resistant to rust and bending

6 Point



- Contents:
 - 1/4" dr hex sockets: 4, 4.5, 5, 5.5, 6, 7, 8, 9, 10, 11, 12, 13, 14mm
 - 1/4" dr hex sockets deep: 5, 6, 7, 8, 9, 10, 11, 12, 13mm
 - Ratchet handle: 145mm
 - Extension bars: 50, 100, 150mm
 - Universal joint
 - Spinner handle
 - Magnetic socket pick-up
 - Sliding T-bar
 - Hex ball allen key - long: 1.5, 2, 2.5, 3, 4, 5, 6, 8, 10mm
 - 1/4" Socket bits 32mm long
 - Flat: 4, 5.5, 6.5mm
 - Torx®: T8, T10, T15, T20, T25, T27, T30, T40
 - Hex: 3, 4, 5, 6, 7, 8, 10mm
 - Phillips: No1, No 2, No 3
 - Pozi driv: No1, No 2, No 3



DIN	DIN	DIN
3122	3123	3124

Part No.	Size
RIC3418	63 Piece

Automotive



SUPER DRIVE SOCKET SET ON RAIL - 1/4" SET 12 PIECE - RT4/272B

1/4"

- Super Drive socket is the only tool you need for all varieties of bolts
- Round is not the perfect shape, six sided and wedge shaped sockets will damage bolts and nuts when transferring high forces
- Super drive sockets have a unique profile which enables the use of sockets on metric, SAE, Torx®, spline and square shaped bolts and nuts
- Chrome vanadium steel, correctly hardened and tempered for maximum strength and durability
- Satin chrome plated for corrosion protection

- Supplied with steel rail, pre-punched for wall mounting
- Contents:
- Super drive sockets: 4, 4.5, 5, 5.5, 6, 7, 8, 9, 10, 11, 12, 13mm



Part No.	Size
RIC6300	12 Piece

Super-Drive
One socket/spanner for every type of bolt!



1/4" DRIVE HEX SOCKET SET - 19 PIECE - 40/13/6

- Stahlwille HPQ (high performance quality) sockets are manufactured from selected tough steel alloys
- Their extremely thin walls and unbelievably high load capacity are simply exemplary
- Stahlwille sockets are equipped with the AS Drive (anti slip drive) profile
- This permits high transmission of forces to lands of nuts and bolts without damaging them
- In sturdy sheet steel case

- Contents:
- 13 x Hexagon sockets: No.40 3.5, 4, 4.5, 5, 5.5, 6, 7, 8, 9, 10, 11, 12, 13mm
- 1 x Ratchet: 415
- 2 x Extensions: 405/2 (54mm), 405/6 (150mm)
- 1 x Universal joint: 407
- 1 x Drive handle: 400
- 1 X T- Handle: 404



Part No.	Ref
STW96010124	40/13/6



1/4" DRIVE HEX SOCKET SET - 30 PIECE - 40/24/QR

- Stahlwille HPQ (high performance quality) sockets are manufactured from selected tough steel alloys
- Their extremely thin walls and unbelievably high load capacity are simply exemplary
- Stahlwille sockets are equipped with the AS Drive (anti slip drive) profile
- This permits high transmission of forces to lands of nuts and bolts without damaging them
- In sturdy ABS plastic case

- Contents:
- 12 x Hexagon sockets: No 40 4, 5, 5.5, 6, 7, 8, 9, 10, 11, 12, 13, 14mm
- 3 x Screwdriver sockets flat: 41K 0.6 x 3.5, 1.0 x 5.5, 1.2 x 8mm
- 5 x Inhex sockets: 44K 3, 4, 5, 6, 8mm
- 2 x Screwdriver sockets Phillips: 44P 1, 2
- 2 Screwdriver sockets Pozi drive 44PZ 1, 2
- 1 x Ratchet: 415QR
- 2 x Extensions: 405QR/2 (54mm), 405QR/6 (150mm)
- 1 x Universal joint: 407QR
- 1 x Drive handle: 400QR
- 1 x T- Handle



Part No.	Ref
STW96010182	40/24/6QR



1/4" DRIVE HEX SOCKET SET - 13 PIECE - 40AD/9/4

- Stahlwille HPQ (high performance quality) sockets are manufactured from selected tough steel alloys
- Their extremely thin walls and unbelievably high load capacity are simply exemplary
- Stahlwille sockets are equipped with the AS Drive (anti slip drive) profile
- This permits high transmission of forces to lands of nuts and bolts without damaging them
- In sturdy sheet steel case

- Contents
- 9 x Bi-Hexagon sockets : 40ad 3/16" 7/32" 1/4" 9/32" 5/16", 11/32" 3/8" 7/16" 1/2"
- 1 x Ratchet 415
- 2 x Extensions: 405/2 (54mm), 405/6 (150mm)
- 1 x Universal joint 407



Part No.	Ref
STW96015302	40AD/9/4



1/4" DRIVE HEX SOCKET SET - 33 PIECE - 40MA/25/8N

- Stahlwille HPQ (high performance quality) sockets are manufactured from selected tough steel alloys
- Their extremely thin walls and unbelievably high load capacity are simply exemplary
- Stahlwille sockets are equipped with the AS Drive (anti slip drive) profile
- This permits high transmission of forces to lands of nuts and bolts without damaging them
- In sturdy sheet steel case

- Contents:
- 25 x Hexagon sockets: No40 3.2, 3.5, 4, 4.5, 5, 5.5, 6, 7, 8, 9, 10, 11, 12, 13, 14mm
- No 40A 3/16", 7/32", 1/4", 9/32", 5/16", 11/32", 3/8", 7/16", 1/2", 9/16"
- 1 x Ratchet: 415
- 2 x Extensions: 405/2 (54mm), 405/6 (150mm)
- 1 x Extension, flexible 406 (152mm)
- 1 x Universal joint 407
- 1 x Drive handle 400
- 1 x Flexible handle 403
- 1 X T- Handle 404



Part No.	Ref
STW96010162	40MA/25/8N

Automotive

COMBO SETS



SOCKETS - SUPER DRIVE SET - 1/4" & 3/8" 45 PIECE - RT4/393B

Super-Drive
One socket/spanner for every type of bolt!

- Super drive socket is the only tool you need for all varieties of bolts
- Round is not the perfect shape, six sided and wedge shaped sockets will damage bolts and nuts when transferring high forces

- Super drive sockets have a unique profile which enables the use of sockets on metric, SAE, Torx®, spline and square shaped bolts and nuts
- Chrome vanadium steel, correctly hardened and tempered for maximum strength and durability
- Satin chrome plated for corrosion protection
- Supplied blow case
- Contents:
- Super drive sockets 1/4" drive: 4, 4.5, 5, 5.5, 6, 7, 8, 9mm
- Super drive sockets 3/8" drive: 10, 11, 12, 13, 14, 15, 16, 17, 18, 19mm
- Spinner handle: 1/4" drive
- Hex coupler: 1/4" x 1/4"
- Adaptor: 1/4"(M) x 3/8"(F)
- Ratchet: 3/8" drive
- Extension: 3/8" drive 75mm
- Spark plug socket: 3/8" drive 16, 21mm
- Bits 1/4" hex
- Hexagon: 3, 4, 5, 6mm
- Flat: 4, 5.5, 7mm
- Phillips: No 1, No 2, No 3
- Pozi driv: No 1, No 2, No 3
- Torx®: T8, T10, T15, T25, T27, T30, T40

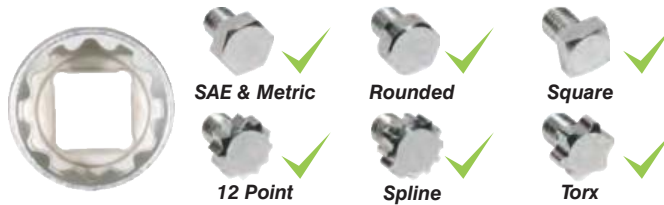
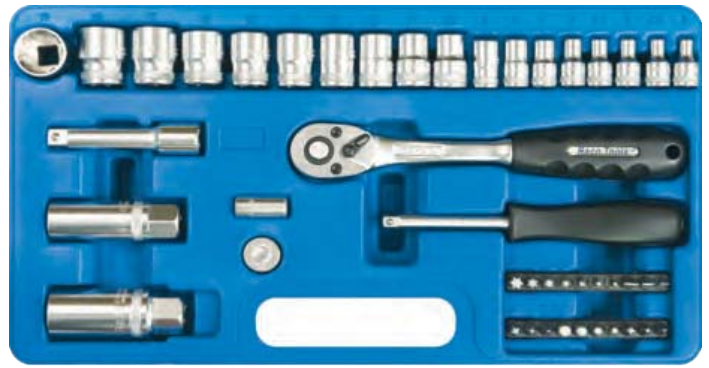

One socket for every type of bolt!

Part No.	Size
RIC6330	45 Piece

DIN	DIN	DIN
3122	3123	3124



SOCKETS - SUPER DRIVE SET - 1/4", 3/8" & 1/2" 111 PIECE - RT4/511B

Super-Drive
One socket/spanner for every type of bolt!

- Super drive socket is the only tool you need for all varieties of bolts
- Round is not the perfect shape, six sided and wedge shaped sockets will damage bolts and nuts when transferring high forces
- Super drive sockets have a unique profile which enables the use of sockets on metric, SAE, Torx®, spline and square shaped bolts and nuts
- Chrome vanadium steel, correctly hardened and tempered for maximum strength and durability
- Satin chrome plated for corrosion protection
- Supplied blow case
- Contents:
- Super drive sockets 1/4" drive: 3.2, 4, 4.5, 5, 5.5, 6, 7, 8, 9, 10, 11, 12, 13mm
- Spark plug socket: 3/8" drive 14, 18mm
- Spark plug socket 1/2" drive 16, 21mm
- Super drive socket 3/8" drive: 9, 10, 11, 12, 13, 14, 15, 16, 17, 18, 19mm
- Super drive sockets 1/2" drive: 14, 15, 16, 17, 18, 19, 20, 21, 22, 23, 24, 27, 30, 32mm
- Spinner handle 1/4"
- Sliding T-Bar 1/4"
- Super drive Combination spanner: 8, 9, 10, 11, 12, 13, 14, 15, 16, 17, 18, 19mm
- Allen key: 1.5, 2, 2.5mm
- Ratchet 1/4" drive
- Ratchet 3/8" drive
- Ratchet 1/2" drive
- Adaptor: 3/8"(F) x 1/4"(M), 3/8"(F) x 1/2"(M), 1/2"(F) x 3/8"(M)
- Extension 1/4" drive: 50, 150mm
- Extension 3/8" drive: 75, 150mm
- Extension 1/2" drive: 125, 250mm
- Socket bits 1/4" Drive:
- Hexagon: 3, 4, 5, 6, 7, 8mm
- Flat: 4, 5.5, 7mm
- Phillips: No 1, No 2, No 3
- Pozi driv: No 1, No 2, No 3
- Universal joint 1/4" drive
- Universal joint 3/8" drive
- Universal joint 1/2" drive
- Coupler: 3/8"dr x 5/16 Hex, 1/2"dr x 5/16" Hex
- Spline: T10, T15, T20, T25, T30, T40



**Super Drive
Combination Spanner Set
Stored in lid**



- Socket bits 5/16" Drive:
- Hexagon: 8, 10, 12, 14mm
- Flat: 8, 10, 12mm
- Phillips: No 3, No 4
- Pozi driv: No 3, No 4
- Spline: T40, T45, T50, T55

DIN	DIN	DIN
3122	3123	3124

Part No.	Size
RIC6340	111 Piece

Automotive



SOCKET COMBO SET - 1/4" & 1/2" DRIVE PROFI-PLUS 43 PIECE - RT5/532

COMBO
SETS

- Manufactured from chrome vanadium steel
- Hardened and tempered for maximum strength
- Socket ends chamfered to allow for positive location and entry
- Satin chrome finish for maximum corrosion protection
- Square drives incorporate spring-loaded retaining ball for secure socket holding
- Case engineered from high impact PVC to be completely resistant to rust and bending
- Contents:
- 1/4" Drive Super lock sockets: 4, 4.5, 5, 5.5, 6, 7, 8, 9, 10, 11, 12, 13, 14mm
- 1/2" Drive Bi-hex sockets: 10, 11, 12, 13, 14, 15, 16, 17, 18, 19, 20, 21, 22, 23, 24, 27, 30, 32mm
- Ratchet Handle: 145mm
- Extension Bars: 50, 150mm
- Sliding T Bar
- Universal Joint
- Spinner
- Ratchet Handle: 245mm
- Swivel Handle: 375mm
- Extension Bars: 125, 250mm
- Sliding T Bar
- Universal Joint



DIN 3122	DIN 3123	DIN 3124
----------	----------	----------

Part No.	Size
RIC3422	43 Piece



SOCKET COMBO SET – 1/4" & 1/2" DRIVE PROFI-PLUS 87 PIECE - RT5/534

- Super drive socket is the only tool you need for all varieties of bolts
- Round is not the perfect shape, six sided and wedge shaped sockets will damage bolts and nuts when transferring high forces
- Super drive sockets have a unique profile which enables the use of sockets on metric, SAE, Torx®, spline and square shaped bolts and nuts
- Chrome vanadium steel, correctly hardened and tempered for maximum strength and durability
- Satin chrome plated for corrosion protection
- Supplied Blow case
- Contents:
- **1/4" Drive**
- 14 - 6 Pt. flank sockets 3.2, 4, 4.5, 5, 5.5, 6, 7, 8, 9, 10, 11, 12, 13, 14mm
- 9 - 6Pt deep flank drive sockets 5, 6, 7, 8, 9, 10, 11, 12, 13mm
- Ratchet 1/4" drive
- Spinner handle
- Extensions 1/4" drive 50, 100, 150mm
- Sliding T-bar
- Universal Joint
- Magnetic Socket Pick-up
- Socket Bits 32mm Long
- Hexagon 3, 4, 5, 6, 7, 8, 10mm
- Flat 4, 5.5, 6.5mm
- Phillips No 1, No 2, No 3
- Pozi drive No 1, No 2, No 3
- Spline T8, T10, T15, T20, T25, T27, T30, T40
- **1/2" Drive**
- 18 - 6 Pt. flank sockets 10, 11, 12, 13, 14, 15, 16, 17, 18, 19, 20, 21, 22, 23, 24, 27, 30, 32mm
- Universal Joint
- Extensions 125, 250mm
- Ratchet
- Adaptor For Extension 3/8" F x 1/2" M
- Allen keys Ball Point Long Series 1.5, 2, 2.5, 3, 4, 5, 6, 8, 10mm



DIN 3122	DIN 3123	DIN 3124
----------	----------	----------



Part No.	Size
RIC3424	87 Piece

Automotive

COMBO SETS



SOCKETS - SUPER DRIVE SET - 1/4" & 1/2" - 68 PIECE - RT4/498B

Super-Drive
One socket/spanner for every type of bolt!

- Super drive socket is the only tool you need for all varieties of bolts
- Round is not the perfect shape, six sided and wedge shaped sockets will damage bolts and nuts when transferring high forces
- Super drive sockets have a unique profile which enables the use of sockets on metric, SAE, Torx®, spline and square shaped bolts and nuts
- Chrome vanadium steel, correctly hardened and tempered for maximum strength and durability
- Satin chrome plated for corrosion protection
- Supplied Blow case
- Contents:
 - Super drive sockets 1/4" drive: 4, 4.5, 5, 5.5, 6, 7, 8, 9, 10, 11, 12, 13, 14mm
 - Super drive sockets 1/2" drive: 10, 11, 12, 13, 14, 15, 16, 17, 19, 21, 22, 24, 27, 30, 32mm
 - Spark plug socket 1/2" drive 16, 21mm
 - Spinner handle 1/4"
 - Sliding T-Bar 1/4"
 - Super drive Combination spanner: 10, 11, 12, 13, 14, 15, 17, 19mm
 - Allen key: 1.5, 2, 2.5mm
 - Ratchet 1/4" drive
 - Adaptor: 1/2" (M) x 3/8" (F)
 - Ratchet 1/2" drive
 - Socket bits 1/4" Drive:
 - Hexagon: 3, 4, 5, 6mm
 - Flat: 4, 5.5, 7mm
 - Phillips: No 1, No 2, No 3
 - Pozi driv: No 1, No 2
 - Spline: T10, T15, T20, T25, T30
 - Extension 1/4" drive: 100mm
 - Extension 1/2" drive: 125, 250mm
 - Universal joint 1/4" drive
 - Universal joint 1/2" drive

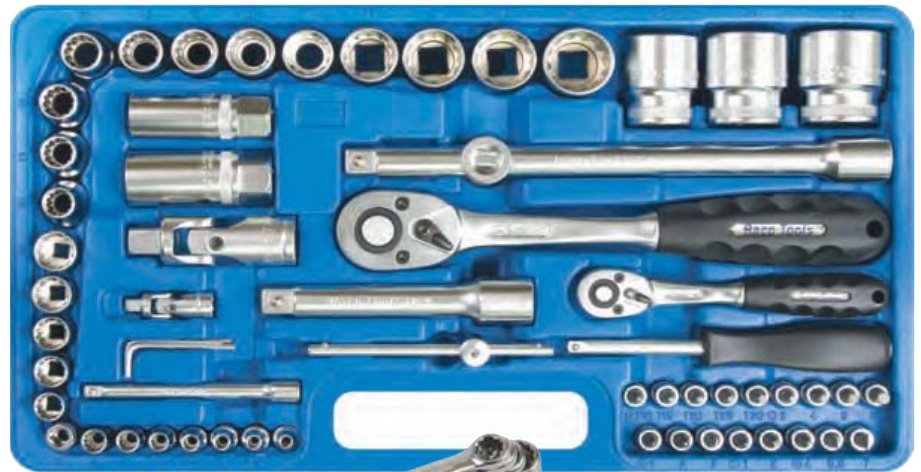

Super Drive
Combination Spanner Set
Stored in lid

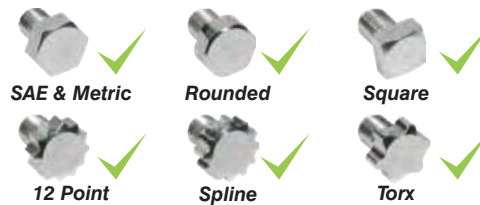

One socket for every type of bolt!

DIN 3122 DIN 3123 DIN 3124

Part No.	Size
RIC6335	68 Piece



SOCKET SET - 3/8" DRIVE - PROFI-PLUS 22 PIECE - RT5/553

3/8"

- Manufactured from chrome vanadium steel
- Hardened and tempered for maximum strength
- Socket ends chamfered to allow for positive location and entry
- Satin chrome finish for maximum corrosion protection
- Square drives incorporate spring-loaded retaining ball for secure socket holding
- Case engineered from high impact PVC to be completely resistant to rust and bending
- Contents:
 - 3/8" Drive Bi-Hex sockets: 6, 7, 8, 9, 10, 11, 12, 13, 14, 15, 16, 17, 18, 19, 22mm
 - Spark plug spanners: 16, 21mm
 - Ratchet handle
 - Extension bars: 75, 150mm
 - Universal Joint
 - Sliding T-handle

12 Point



DIN 3122 DIN 3123 DIN 3124

Part No.	Size
RIC3435	22 Piece

Automotive

141 Combination & 3/8" Socket Sets



SUPER DRIVE SOCKET SET ON RAIL - 3/8" SET 8 PIECE - RT4/383B

DIN
3122

DIN
3123

DIN
3124

3/8"

- Super Drive socket is the only tool you need for all varieties of bolts
- Round is not the perfect shape, six sided and wedge shaped sockets will damage bolts and nuts when transferring high forces
- Super drive sockets have a unique profile which enables the use of sockets on metric, SAE, Torx®, spline and square

- shaped bolts and nuts
- Chrome vanadium steel, correctly hardened and tempered for maximum strength and durability
- Satin chrome plated for corrosion protection
- Supplied with steel rail, pre-punched for wall mounting
- Contents: Super drive sockets 8, 10, 12, 13, 14, 16, 17, 19mm

Super-Drive

One socket/spanner for every type of bolt!



Part No.	Size
RIC6305	8 Piece



SUPER DRIVE SOCKET SET WITH BRACKET - 3/8" SET 12 PIECE - RT4/385B

- Super Drive socket is the only tool you need for all varieties of bolts
- Round is not the perfect shape, six sided and wedge shaped sockets will damage bolts and nuts when transferring high forces
- Super drive sockets have a unique profile which enables the use of sockets on metric, SAE, Torx®, spline and square

- shaped bolts and nuts
- Chrome vanadium steel, correctly hardened and tempered for maximum strength and durability
- Satin chrome plated for corrosion protection
- Supplied with bracket
- Contents: Super drive sockets 8, 9, 10, 11, 12, 13, 14, 15, 16, 17, 19mm
- Ratchet 3/8" drive

Super-Drive

One socket/spanner for every type of bolt!

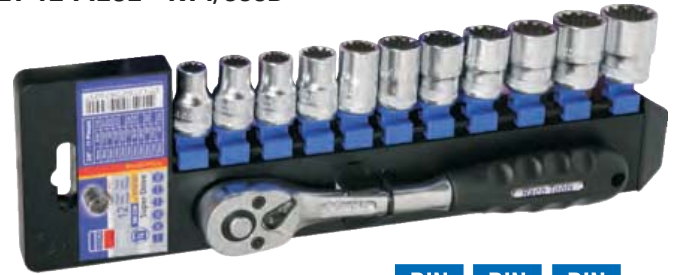

DIN
3122

DIN
3123

DIN
3124

Part No.	Size
RIC6310	12 Piece



3/8" DRIVE - BI-HEX SOCKET SET - 33 PIECES - 45MA/28/5

- Stahlwille HPQ (high performance quality) sockets are manufactured from selected tough steel alloys
- Their extremely thin walls and unbelievably high load capacity are simply exemplary
- Stahlwille sockets are equipped with the AS Drive (anti slip drive) profile
- This permits high transmission of forces to lands of nuts and bolts without damaging them
- In sturdy sheet steel case
- Contents:
- 28 x Bi-Hexagon sockets: No.45: 7, 8, 9, 10, 11, 12, 13, 14, 15, 16, 17, 18, 19, 20, 21, 22mm
- No.45A: 1/4", 5/16", 11/32", 3/8", 7/16", 1/2", 9/16", 5/8", 11/16", 3/4", 13/16", 7/8"
- 1 x Ratchet: 435
- 2 x Extensions: 427/3 (76mm), 427/10 (240mm)
- 1 x T- Handle: 425
- 1 x Universal joint: 428

Part No.	Ref
STW96020122	45MA/28/5



SOCKET - SET 3/8" DRIVE - D30 FMZ

- For manually operated sockets with thin walls and knurled base
- CHROME VANADIUM steel 31CrV3
- Chrome plated and polished
- Contents:
- Accessories:
- 3093Z-94 Ratchet
- 3090/125, Extension
- Inserts: D30 F
- Sockets: D30: 6, 7, 8, 9, 10, 11, 12, 13, 14, 15, 16, 17, 18, 19, 20, 21, 22mm
- Supplied in blue powder coated D30 K-steel box

Part No.
GED623202



Automotive

3/8"



SOCKET - SET 3/8" DRIVE - D30 HMZ

- Contents:
- Accessories:
- 3093Z-94 Ratchet
- 3081 "L" Handle
- 3087 Sliding "T" handle
- 3090/125, 3090/250 Extension

3095 Universal

Inserts: D30 H

Sockets: 30 & D30: 6, 7, 8, 9, 10, 11, 12, 13, 14, 15, 16, 17, 18, 19, 20, 21, 22mm

- Supplied in blue powder coated D19 J-steel box

Part No.

GED623962



SOCKET - SET 3/8" DRIVE C PROFILE - C30 HMZ

- Contents:
- Accessories:
- 3093Z-94 Ratchet
- 3081 Long handle
- 3087 Sliding "T" handle
- 3090/125, 3090/250 Extension
- 3095 Universal joint
- Inserts: D30 H
- Sockets: 30&C30: 6, 7, 8-5/16", 9-11/32", 10-3/8", 11, 12, 13-1/2", 14, 15-19/32", 16-5/8", 17, 18, 19-3/4", 20-25/32", 21-13/16", 22mm
- Supplied in blue powder coated D19 J-steel box

Part No.

GED622346



1/2"



SOCKET SET - SUPER DRIVE - 1/2" DRIVE - 27 PIECE - RT4/495

Super-Drive
One socket/spanner for every type of bolt!

- Super drive socket is the only tool you need for all varieties of bolts
- Round is not the perfect shape, six sided and wedge shaped sockets will damage bolts and nuts when transferring high forces
- Super drive sockets have a unique profile which enables the use of sockets on metric, SAE, Torx®, spline and square shaped bolts and nuts
- Chrome vanadium steel, correctly hardened and tempered for maximum strength and durability
- Satin chrome plated for corrosion protection
- Contents: Super drive sockets 1/2": 8, 9, 10, 11, 12, 13, 14, 15, 16, 17, 18, 19, 20, 21, 22, 23, 24, 27, 30, 32mm
- Ratchet
- Extension bars: 125, 250mm
- Universal Joint
- Spark plug socket: 16, 21mm
- Sliding T-bar

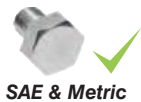
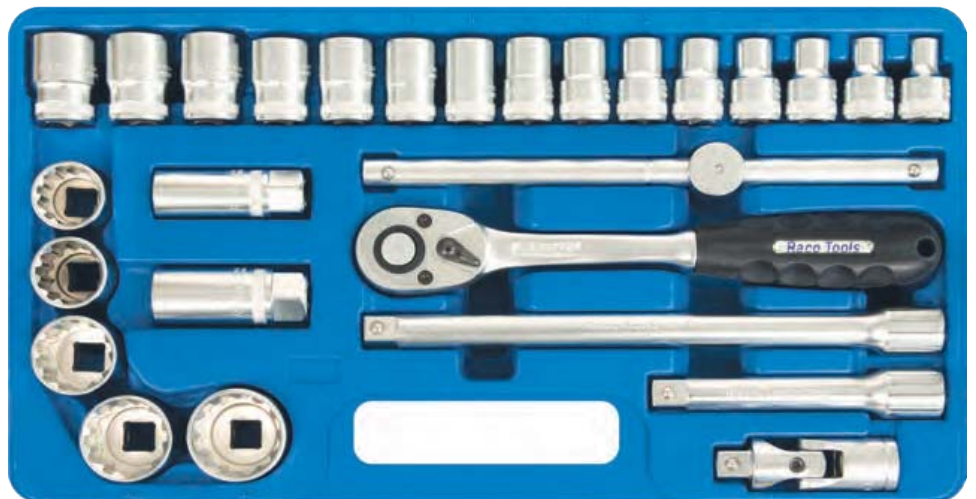

DIN 3122 **DIN 3123** **DIN 3124**

One socket for every type of bolt!

Part No.	Size
RIC6325	27 Piece

143 3/8" & 1/2" Socket Sets

AVAILABLE FROM SELECTED DISTRIBUTORS NATIONWIDE

Automotive



SOCKET SET - 1/2" DRIVE PROFI-PLUS 13 PIECE - RT5/562

1/2"

- Manufactured from chrome vanadium steel
- Hardened and tempered for maximum strength
- Socket ends chamfered to allow for positive location and entry
- Satin chrome finish for maximum corrosion protection
- Square drives incorporate spring-loaded retaining ball for secure socket holding
- Case engineered from high impact PVC to be completely resistant to rust and bending
- Contents:
- 1/2" drive Bi-Hex sockets: 8, 9, 10, 11, 12, 13, 14, 15, 17, 19, 22mm
- Ratchet handle
- Extension bar 125mm

DIN 3122	DIN 3123	DIN 3124
----------	----------	----------

12 Point



Part No.	Size
RIC3440	13 Piece



SOCKET SET - 1/2" DRIVE PROFI-PLUS 28 PIECE - RT5/567

- Manufactured from chrome vanadium steel
- Hardened and tempered for maximum strength
- Socket ends chamfered to allow for positive location and entry
- Satin chrome finish for maximum corrosion protection
- Square drives incorporate spring-loaded retaining ball for secure socket holding
- Case engineered from high impact PVC to be completely resistant to rust and bending
- Contents:
- 1/2" drive Bi-Hex sockets: 8, 9, 10, 11, 12, 13, 14, 15, 16, 17, 18, 19, 20, 21, 22, 23, 24, 27, 30, 32mm
- Ratchet
- Extension bars: 125, 250mm
- Universal joint
- Sliding T bar
- Speed brace
- Spark plug spanners: 16, 21mm

DIN 3122	DIN 3123	DIN 3124
----------	----------	----------

12 Point



Part No.	Size
RIC3445	28 Piece

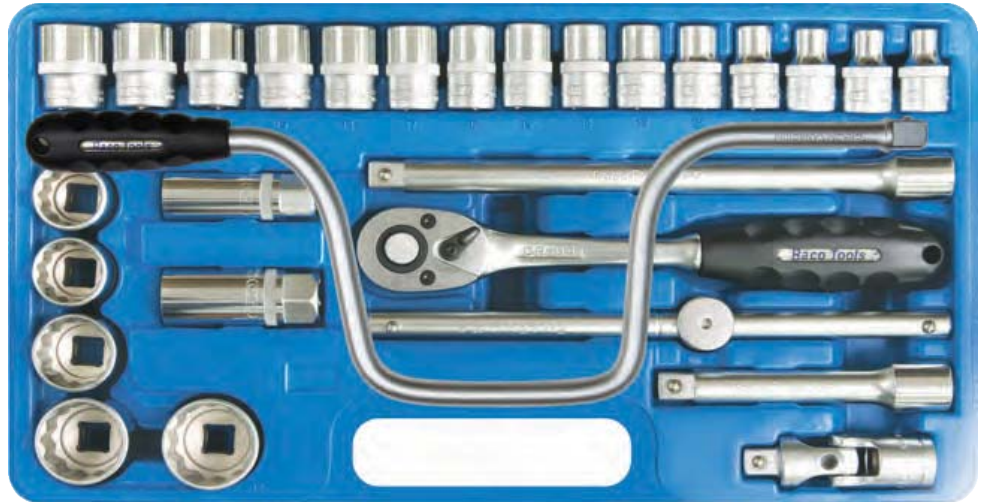

SUPER DRIVE SOCKET SET WITH BRACKET 1/2" SET 11 PIECE - RT4/488B

Super-Drive
One socket/spanner for every type of bolt!

- Super Drive socket is the only tool you need for all varieties of bolts
- Round is not the perfect shape, six sided and wedge shaped sockets will damage bolts and nuts when transferring high forces
- Super drive sockets have a unique profile which enables the use of sockets on metric, SAE, Torx®, spline and square shaped bolts and nuts
- Chrome vanadium steel, correctly hardened and tempered for maximum strength and durability
- Satin chrome plated for corrosion protection
- Supplied with bracket
- Contents: Super drive sockets 10, 11, 12, 13, 14, 15, 17, 19, 22, 24mm
- Ratchet 1/2" drive

Part No.	Size
RIC6320	11 Piece



Automotive

1/2" Socket Sets 144

1/2"



SUPER DRIVE SOCKET SETS ON RAIL - 1/2" DRIVE

Super-Drive
One socket/spanner for every type of bolt!

- Super Drive socket is the only tool you need for all varieties of bolts
- Round is not the perfect shape, six sided and wedge shaped sockets will damage bolts and nuts when transferring high forces
- Super drive sockets have a unique profile which enables the use of sockets on metric, SAE, Torx®, spline and square shaped bolts and nuts
- Chrome vanadium steel, correctly hardened and tempered for maximum strength and durability
- Satin chrome plated for corrosion protection
- Supplied with steel rail, pre-punched for wall mounting

DIN	DIN	DIN
3122	3123	3124

Part No.	Size	Contents	Ref.
RIC6315	8 Piece	8, 10, 12, 13, 14, 16, 17, 19mm	RT4/485B
RIC6317	10 Piece	10, 11, 12, 13, 14, 15, 17, 19, 22, 24mm	RT4/486B



SOCKET SET - 1/2" DRIVE - BI-HEX - 23 PIECES - 50/17/6

- Stahlwille HPQ (high performance quality) sockets are manufactured from selected tough steel alloys
- Their extremely thin walls and unbelievably high load capacity are simply exemplary
- Stahlwille sockets are equipped with the AS Drive (anti slip drive) profile
- This permits high transmission of forces to lands of nuts and bolts without damaging them
- In sturdy steel case
- Contents:
- 17 x Bi-Hexagon sockets: No.50: 10, 11, 12, 13, 14, 15, 16, 17, 18, 19, 21, 22, 24, 27, 30, 32, 34mm
- 1 x Ratchet: 512
- 3 x Extensions: 509/3 (75mm), 509/5 (130mm), 509/10 (255mm)
- 1 x T-Handle: 506
- 1 x Universal joint: 510

Part No.	Ref
STW96030147	50/17/6



SOCKET SET - 1/2" DRIVE - BI-HEX - 23 PIECES - 50A/17/6

- Stahlwille HPQ (high performance quality) sockets are manufactured from selected tough steel alloys
- Their extremely thin walls and unbelievably high load capacity are simply exemplary
- Stahlwille sockets are equipped with the AS Drive (anti slip drive) profile
- This permits high transmission of forces to lands of nuts and bolts without damaging them
- In sturdy steel case
- Content:
- 17 Bi-Hexagon sockets: 50a: 3/8", 7/16", 1/2", 9/16", 19/32", 5/8", 11/16", 3/4", 25/32", 13/16", 7/8", 15/16", 1", 1-1/16", 1-1/8", 1-3/16", 1-1/4"
- 3 x Extensions: 509/3 (75mm), 509/5 (130mm), 509/10 (255mm)
- 1 x Ratchet: 512
- 1 x T-Handle: 506
- 1 x Universal joint: 510

Part No.	Ref
STW96034125	50A/17/6



SOCKET SET-1/2" DRIVE - BI-HEX - 45 PIECES - 50MA/39/6N

- Stahlwille HPQ (high performance quality) sockets are manufactured from selected tough steel alloys
- Their extremely thin walls and unbelievably high load capacity are simply exemplary
- Stahlwille sockets are equipped with the AS Drive (anti slip drive) profile
- This permits high transmission of forces to lands of nuts and bolts without damaging them
- In sturdy steel case
- Content
- 39 Bi-Hexagon sockets No.50 10, 11, 12, 13, 14, 15, 16, 17, 18, 19, 20, 21, 22, 23, 24, 25, 26, 27, 28, 30, 32, 34mm
- No.50a 3/8", 7/16", 1/2", 9/16", 19/32", 5/8", 11/16", 3/4", 25/32", 13/16", 7/8", 15/16", 1", 1 1/16", 1 1/8", 1 3/16", 1 1/4"
- 1 x Ratchet 512
- 3 x Extensions 509/3 (75mm), 509/5 (130mm), 509/10 (255mm)
- 1 x T-Handle 506
- 1 x Universal joint 510

Part No.	Ref
STW96030140	50MA/39/6N



Automotive

145 1/2" Socket Sets

AVAILABLE FROM SELECTED DISTRIBUTORS NATIONWIDE



SOCKET SET - 1/2" DRIVE D19MK

- Manually operated sockets with thin walls and knurled bases
- CHROME VANADIUM steel - 31CrV3
- Chrome plated and polished
- Contents:
Sockets: D19: 8, 10, 11, 12, 13, 14, 15, 16, 17, 19, 22, 23, 24, 26, 27, 28, 30, 32mm
- Supplied in blue powder coated D19 KM-steel box



Part No.

GED614122



SOCKET SET 1/2" DRIVE C19MK

- Manually operated sockets with thin walls and knurled base
- CHROME VANADIUM steel – 31CrV3
- Chrome plated and polished
- Contents:
Sockets: C19: 8-5/16", 10-3/8", 11, 12, 13/1/2", 14, 15-19/32", 16-5/8", 17, 19-3/4", 22, 23, 24-15/16", 26-1", 27-1 1/16", 28, 30-1 3/16", 32-1 1/4"
- Supplied in blue power coated D19 KM-steel box



Part No.

GED612936

1/2"



SOCKET SET 1/2" DRIVE - D19AK

- Manually operated sockets with thin walls and knurled bases
- CHROME VANADIUM steel - 31CrV3
- Chrome plated and polished
- Contents:
Sockets: D19 5/16", 11/32", 3/8", 7/16", 1/2", 9/16", 19/32", 5/8", 11/16", 3/4", 13/16", 7/8", 15/16", 1", 1 1/16", 1 1/8", 1 3/16", 1 1/4"
- Supplied in powder coated D19 KM-steel box



Part No.

GED616419



SOCKET SET - BI-HEX 1/2" DRIVE D19 KMZ

- Manually operated sockets with thin walls and knurled base
 - CHROME VANADIUM steel - 31CrV3
 - Chrome plated and polished
 - Contents:
Insert: D19K
- Accessories:
1993Z-94 Ratchet
1990/125, Extension
Sockets: D19 10, 12, 13, 14, 15, 17, 19, 22, 24, 27mm
- Supplied in blue powder coated D19 K-steel box



Part No.

GED614653



SOCKET SET - BI-HEX 1/2" DRIVE D19 HMZ

- Manually operated sockets with thin walls and knurled base
 - CHROME VANADIUM steel -31CrV3
 - Chrome plated and polished
 - Contents:
Insert: D19H
- Accessories:
1993Z-94 Ratchet
1990/125, Extension
Sockets: D19 8, 10, 11, 12, 13, 14, 15, 16, 17, 19, 22mm
- Supplied in blue powder coated D19 K-steel box



Part No.

GED614610



SOCKET SET 1/2" DRIVE - C19HMZ

- Manually operated sockets with thin walls and knurled base
 - CHROME VANADIUM steel - 31CrV3
 - Chrome plated and polished
 - Contents:
Insert D19 H
- Accessories:
1993Z-94 Ratchet
1990/125 Extension
Sockets: C19 8-5/16", 10-3/8", 11, 12, 13-1/2", 14, 15-19/32", 16-5/8", 17, 19-3/4", 22mm
- Supplied in blue powder coated, D19 K-steel box



Part No.

GED612286

Automotive

1/2"



SOCKET SET - BI-HEX 1/2" DRIVE - D19/22 TMZ

- Manually operated sockets with thin walls and knurled bases
- CHROME VANADIUM steel - 31CrV3
- Chrome plated and polished
- Contents:
- Insert: D19/22 T
- Accessories:
- 1993Z-94 Ratchet
- 1987 Sliding "T" Bar
- 1990/125, 1990/250 Extension
- 1995 Universal joint
- Sockets:
- D19: 8, 9, 10, 11, 12, 13, 14, 15, 16, 17, 18, 19, 20, 21, 22, 24, 26, 27, 28, 29, 30, 32mm
- Supplied in blue powder coated steel box: D19 T



Part No.

GED616524



SOCKET SET - BI-HEX 1/2" DRIVE D19/22 TMU-10T

- Manually operated sockets with thin walls and knurled bases
- CHROME VANADIUM steel - 31CrV3
- Chrome plated and polished
- Contents:
- Insert: D19/22 T
- Accessories:
- 1993U-10T Ratchet
- 1987 Sliding "T" bar
- 1990/125, 1990/250 Extension
- 1995 Universal joint
- Sockets:
- D19: 8, 9, 10, 11, 12, 13, 14, 15, 16, 17, 18, 19, 20, 21, 22, 24, 26, 27, 28, 29, 30, 32mm
- Supplied in blue powder coated steel box: D19 Y



Part No.

GED616532



SOCKET - SET - BI-HEX 1/2" DRIVE D19 TMU-10T

- Manually operated sockets with thin walls and knurled base
- CHROME VANADIUM steel - 31CrV3
- Chrome plated and polished
- Contents:
- Insert: D19T
- Accessories:
- 1993U-10T Ratchet
- 1985 Speed brace handle
- 1987 Sliding "T" bar
- 1990/125, 1990/250 Extension
- 1995 Universal joint
- Sockets: D19: 8, 10, 11, 12, 13, 14, 15, 16, 17, 19, 21, 22, 23, 24, 26, 27, 28, 30, 32mm
- Supplied in blue powder coated steel box: D19 T



Part No.

GED615196



SOCKET SET - 1/2" DRIVE - BI-HEX D19TAU-10T

- Manually operated sockets
- Knurled base
- Chrome vanadium steel 31CrV3
- Chrome plated and polished
- Supplied in blue powder coated steel case with matt black finish insert
- CONTENTS:
- Sockets: 5/16", 3/8", 13/32", 7/16", 1/2", 9/16", 19/32", 5/8", 11/16", 3/4", 25/32", 13/16", 7/8", 15/16", 1", 1-1/16", 1-1/8", 1-3/16", 1-1/4"
- Accessories:
- 1993U-10T Ratchet Spanner
- 1990 / 125 Extension bar 125mm
- 1990 / 250 Extension bar 250mm
- 1985 Speed brace
- 1995 Universal joint
- 1987 Sliding "T" bar
- D19 T- Insert
- D19 T- Box



Part No.

GED616206

Automotive

147 1/2" Socket Sets

AVAILABLE FROM SELECTED DISTRIBUTORS NATIONWIDE



SOCKET SET - BI-HEX 1/2" DRIVE D19 TMZ

- Manually operated sockets with thin walls and knurled base
- CHROME VANADIUM steel - 31CrV3
- Chrome plated and polished
- Contents: Insert: D19T
- Accessories: 1993Z-94 Ratchet 1985 Speed brace handle
- 1987 Sliding "T" bar
- 1990/125, 1990/250 Extension
- 1995 Universal joint
- Sockets: D19: 8, 10, 11, 12, 13, 14, 15, 16, 17, 19, 21, 22, 23, 24, 26, 27, 28, 30, 32mm
- Supplied in blue powder coated steel box: D19 T



Part No.

GED614831



SOCKET SET BI-HEX 1/2" DRIVE - D19 TM97-Z

- Manually operated sockets with thin walls and knurled base
- CHROME VANADIUM steel - 31CrV3
- Chrome plated and polished
- Contents: Insert: D19T 97
- Accessories: 1993Z-94 Ratchet
- 1990/125, 1990/250 Extension
- 1997/375 Power bar
- 50-20.8 Spark plug socket Sockets: D19: 10, 11, 12, 13, 14, 15, 16, 17, 19, 20, 22, 24, 27, 30, 32mm
- Supplied in blue powder coated steel box: D19 T



Part No.

GED615293

1/2"



SOCKET SET - BI-HEX 1/2" DRIVE D19 TMAZ

- Manually operated sockets with thin walls and knurled base
- CHROME VANADIUM steel - 31CrV3
- Chrome plated and polished
- Contents: Insert: D19T
- Accessories: 1993Z-94 Ratchet
- 1985 Speed brace handle
- 1987 Sliding "T" bar
- 1990/125, 1990/250 Extension
- 1995 Universal joint
- Sockets: D19: 10, 13, 14, 15, 16, 17, 19, 21, 22, 23, 24, 26, 27, 28, 30, 32mm
- Supplied in blue powder coated steel box: D19 T



Part No.

GED614572



SOCKET SET 1/2" DRIVE - C19TMZ

- Manually operated sockets with thin walls and knurled base
- CHROME VANADIUM steel - 31CrV3
- Chrome plated and polished
- Contents: Insert: D19 T
- Accessories: 1993Z-94 Ratchet 1985 Speed brace handle 1987 Sliding "T" handle
- 1990/125, 1990/250 Extension
- 1995 Universal joint
- Sockets: C19: 8-5/16", 10-3/8", 11, 12, 13-1/2", 14, 15-19/32", 16-5/8", 17, 18, 19-3/4", 21-13/16", 22, 24-15/16", 26-1", 27-1 1/16", 29-1 1/8", 30-1 3/16", 32-1 1/4"
- Supplied in blue powder coated sheet box: D19 T



Part No.

GED612456

Automotive

1/2" Socket Sets 148

1/2"



SOCKET SET - 1/2" DRIVE C PROFILE - C19/22TMZ

- Manually operated sockets with thin walls and knurled base
- CHROME VANADIUM steel - 31CrV3
- Chrome plated and polished
- Contents:
- Insert D19/22T
- Accessories:
- 1993Z-94 Ratchet
- 1987 Sliding "T" bar
- 1990/125 extension, 1990/250 extension
- 1995 Universal joint
- Sockets: C19: 8-5/16", 9-11/32", 10-3/8", 11, 12, 13-1/2", 14, 15-19/32", 16-5/8", 17, 18, 19-3/4", 20-25/32", 21-13/16", 22, 24-15/16", 26-1", 27-1 1/16", 28, 29-1 1/8", 30-1 3/16", 32-1 1/4"
- Supplied in blue powder coated, steel box: D19 T



Part No.

GED611980



SOCKET SET - BI-HEX 1/2" DRIVE D19 YMAU-10T

- Manually operated sockets with thin walls and knurled bases
- CHROME VANADIUM steel - 31CrV3
- Chrome plated and polished
- Contents:
- Insert: D19 Y
- Accessories:
- 1993U-10T Ratchet
- 1985 Speed brace handle
- 1987 Sliding "T" bar
- 1990/125, 1990/250 Extension
- 1995 Universal joint
- 50-20.2 Spark plug socket
- Sockets: D19: 8, 9, 10, 11, 12, 13, 14, 15, 16, 17, 18, 19, 20, 21, 22, 23, 24, 27mm
- Sockets: D19 5/16", 11/32", 3/8", 13/32", 7/16", 1/2", 9/16", 19/32", 5/8", 11/16", 3/4", 25/32", 13/16", 7/8", 15/16", 1"
- Supplied in blue powder coated steel box: D19 Y



Part No.

GED616222



SOCKET SET - BI-HEX 1/2" DRIVE D19 IBMZ

- Manually operated sockets with thin walls and knurled bases
- CHROME VANADIUM steel - 31CrV3
- Chrome plated and polished
- Contents:
- Insert: D19 1B
- Accessories:
- 1993Z-94 Ratchet
- 1990/125, Extension
- 137/250 Grip Plier
- 141/250 Universal Plier
- Sockets: D19: 10, 11, 12, 13, 14, 15, 16, 17, 19, 22mm
- Spanner: 1B: 10, 11, 13, 14, 17, 19, 22mm
- Supplied in blue powder coated steel box: D19 1B



Part No.

GED615595



SOCKET - SET - BI-HEX 1/2" DRIVE D19 YM1B-10T

- Manually operated sockets with thin walls and knurled bases
- CHROME VANADIUM steel - 31CrV3
- Chrome plated and polished
- Contents:
- Insert: D19 YM1B
- Accessories:
- 1993U-10T Ratchet
- 1990/125, Extension
- 1997/375 Power bar
- 50-20.8 Spark plug socket
- Sockets: D19: 10, 11, 12, 13, 14, 15, 16, 17, 19, 22, 24mm
- Spanners: 1B: 10, 11, 12, 13, 14, 15, 16, 17, 19, 22, 24mm
- Supplied in blue powder coated steel box: D19 Y



Part No.

GED616230

Automotive

149 1/2" Socket Sets

AVAILABLE FROM SELECTED DISTRIBUTORS NATIONWIDE



SOCKET SET - BI-HEX 1/2" DRIVE - D19 62MU-10T

- Manually operated sockets with thin walls and knurled bases
- CHROME VANADIUM steel - 31CrV3
- Chrome plated and polished
- Contents:
- Insert: D19 T
- Accessories:
- 1993U-10T Ratchet
- 1985 Speed brace handle
- 1987 Sliding "T" bar
- 1990/125, 1990/250 Extension
- 1995 Universal joint
- Sockets: D19: 5/16", 3/8", 13/32", 7/16", 1/2", 9/16", 19/32", 5/8", 11/16", 3/4", 25/32", 13/16", 7/8", 15/16", 1", 1-1/16", 1-1/8", 1-3/16", 1-1/4"
- Supplied in blue powder coated steel box: D19 T

Part No.

GED616001



1/2"



SOCKET SET - HEX BIT 8 PIECE - RT5/228

- Manufactured from chrome vanadium steel with high quality S2 screwdriver head
- Hardened and tempered and precision machined to deliver maximum turning power for maximum strength
- Satin chrome plated for corrosion protection
- Contents:
- Hex socket bits:
- 5, 6, 7, 8, 10, 12mm x 55mm long
- 14mm x 65 mm long
- 17mm x 70 mm long
- Case engineered from high impact PVC to be completely resistant to rust and bending

Part No.

RIC3470

Size

8 Piece



SOCKET - WITH HEXAGON BITS 1/2"DRIVE SET 10 PIECE - IN19 PM-10

- For hexagon head screws
- Manually operated sockets with knurled base
- Sockets - CHROME VANADIUM steel - 31CrV3
- Bits - CHROME VANADIUM steel - 59CrV4
- Insert: IN19PM - 10
- Contents:
- Sockets:
- IN19: 5, 6, 7, 8, 9, 10, 12, 14, 17, 19mm
- Supplied in black matt finish insert

Part No.

GED617415



SOCKET - WITH HEXAGON BITS 1/2"DRIVE SET 10 PIECE - IN19 PM-5D

- For hexagon head screws
- Manually operated sockets with knurled base
- Sockets - CHROME VANADIUM steel - 31CrV3
- Bits - CHROME VANADIUM steel - 59CrV4
- Insert: IN19 - 5D
- Contents:
- Sockets:
- IN19: 6, 8, 10, 12, 14mm
- IN19L: 6-100, 8-100, 10-100, 12-100, 14-100mm
- Supplied in black matt finish insert

Part No.

GED617423



SOCKET - WITH HEXAGON BITS 1/2"DRIVE SET 10 PIECE - IN19 PA-10

- For hexagon head screws
- Manually operated sockets with knurled base
- Sockets - CHROME VANADIUM steel - 31CrV3
- Bits - CHROME VANADIUM steel - 59CrV4
- Insert: IN19PA - 10
- Contents:
- Sockets:
- IN19: 3/16", 7/32", 1/4", 9/32", 5/16", 3/8", 1/2", 9/16", 5/8"
- IKS19: 2
- Supplied in black matt finish insert

Part No.

GED617431



Automotive

1/2" Socket Sets 150

1/2"



SOCKET WITH HEXAGON BITS 1/2" DRIVE SET 6 PIECE IN19 PA-6

- For hexagon head screws
- Manually operated sockets with knurled base
- Sockets - CHROME VANADIUM steel - 31CRV3

- Bits - CHROME VANADIUM steel - 59CrV4
- Insert: IN19 - 6
- Contents:
- Sockets:
- IN19: 3/16", 1/4", 5/16", 3/8", 1/2", 9/16"
- Supplied in black matt finish insert



Part No.

GED617849



SOCKET WITH HEXAGON BITS 1/2" DRIVE SET 6 PIECE- IN19 PM-6

- For hexagon head screws
- Manually operated sockets with knurled base
- Sockets - CHROME VANADIUM steel - 31CRV3
- Bits - CHROME VANADIUM steel - 59CrV4
- Insert: IN19 - 6
- Contents:
- Sockets:
- IN19: 5, 6, 8, 10, 12, 14mm
- Supplied in black matt finish insert



Part No.

GED617474



SOCKET SET - TORX® -1/2" DRIVE 9 PIECE - RT5/229

- Manufactured from chrome vanadium steel with high quality S2 screwdriver head
- Hardened and tempered and precision machined to deliver maximum turning power for maximum strength
- Satin chrome plated for corrosion protection
- Contents:
- Torx® socket bits: T20, T25, T27, T30, T40, T45, T50, T55, T60 x 55mm long
- Case engineered from high impact PVC to be completely resistant to rust and bending



Part No.

RIC3474

Size

9 Piece



SOCKET - SET TORX® MALE 1/2" DRIVE - ITX 19-MT

- For protruding TORX head screws
- Manually operated sockets with thin walls and knurled base
- CHROME VANADIUM STEEL - 31CrV3
- Chrome plated
- Contents:
- Insert: TX 19-MT
- Sockets:
- ITX19: T20, T25, T27, T30, T40, T45, T50
- Supplied in blue powder coated, D30 K-steel box



Part No.

GED665983



SOCKET - SET TORX® FEMALE 1/2" DRIVE - TX19-FT

- For protruding TORX head screws
- Manually operated sockets with thin walls and knurled base
- CHROME VANADIUM STEEL - 31CrV3
- Chrome plated
- Contents:
- Insert: ITX19 - FT
- Sockets:
- ITX19: E10, E11, E12, E14, E16, E18, E20, E24
- Supplied in blue powder coated, D19 J-steel box



Part No.

GED665991

Automotive

151 1/2" Socket Sets

AVAILABLE FROM SELECTED DISTRIBUTORS NATIONWIDE



SOCKET - SET TORX® MALE & FEMALE 1/2" DRIVE - ITX/TX19 - FMT

1/2"

- For protruding TORX head screws
- Manually operated sockets with thin walls and knurled base
- CHROME VANADIUM STEEL - 31CrV3
- Chrome plated
- Contents:
- Insert: ITX/TX19 - FM
- Sockets:
- ITX19: T20, T25, T27, T30, T40, T45, T50
- TX19: E10, E11, E12, E14, E16, E18, E20, E24
- Supplied in blue powder coated, D19 J-steel box



Part No.

GED666009



SOCKET- WITH SPLINE BITS 1/2" DRIVE SET 6 PIECE - INX19-6

- For multi-point screws
- Manually operated sockets with knurled base
- Sockets - CHROME VANADIUM steel - 31CRV3
- Bits - Molybdenum tool steel
- Insert: IN19 - 6
- Contents:
- Sockets:
- INX19: 5, 6, 8, 10, 12mm
- IKS19: 2
- Supplied in black matt finish insert



Part No.

GED617601



SOCKET - WITH SPLINE BITS 1/2"DRIVE SET 10 PIECE - INX19 PM-5D

- For multi-point screws
- Manually operated sockets with knurled base
- Sockets - CHROME VANADIUM steel - 31CRV3
- Bits - Molybdenum tool steel
- Insert: IN19 - 5D
- Contents:
- Sockets:
- INX19: 5, 6, 8, 10, 12mm
- INX19L: 6-100, 8-100, 10-100, 12-100mm
- IKS19: 2
- Supplied in black matt finish insert



Part No.

GED617989



SOCKET SET - SPLINE - 1/2" DRIVE 6 PIECE - RT5/226

- Manufactured from chrome vanadium steel with high quality S2 screwdriver head
- Hardened and tempered and precision machined to deliver maximum turning power
- for maximum strength
- Satin chrome plated for corrosion protection
- Contents:
- Spline socket bits:
- M6, M8, M10 x 55mm long
- M8, M10, M12 x 100mm long
- Case engineered from high impact PVC to be completely resistant to rust and bending



Part No.

RIC3472

Size

6 Piece

Automotive

1/2" Socket Sets 152

3/4"



SOCKET SET - 3/4" DRIVE 14 PIECE - RT5/662

- Manufactured from chrome vanadium steel
- Hardened and tempered
- Chrome plated for long service life
- Socket ends and square drives are chamfered
- Square drives fitted with spring loaded locking ball for secure fit
- High impact PVC case - completely resistant to rust and bending
- Contents:
- Bi-Hex sockets: 22, 24, 27, 30, 32, 36, 38, 41, 46, 50mm
- Ratchet
- Extension bars: 100, 200mm
- Sliding T- bar

DIN	DIN	DIN
3122	3123	3124



Part No.	Size
RIC3450	14 Piece

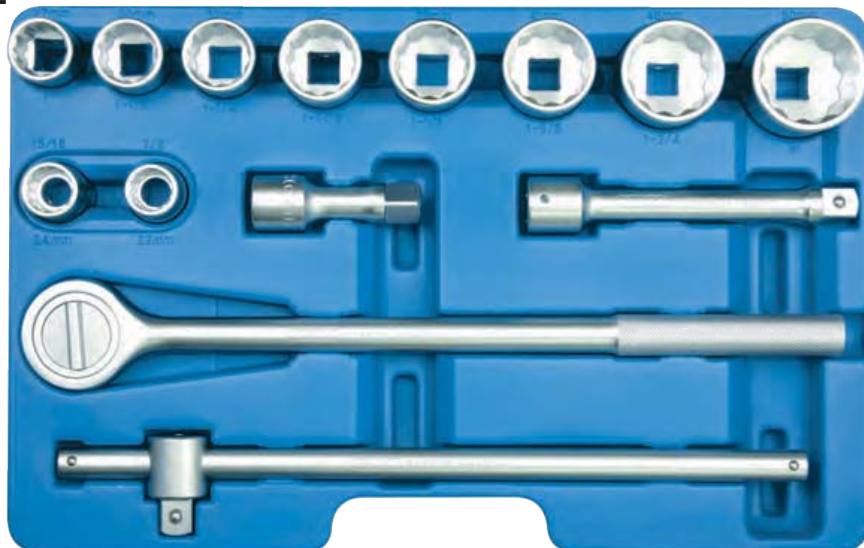

SOCKET SET - 3/4" DRIVE HEXAGON - 15 PIECES - 55/9/6N

- Stahlwille HPQ (high performance quality) sockets are manufactured from selected tough steel alloys
- Their extremely thin walls and unbelievably high load capacity are simply exemplary
- Stahlwille sockets are equipped with the AS Drive (anti slip drive) profile (up to 38mm)
- This permits high transmission of forces to lands of nuts and bolts without damaging them
- In sturdy sheet steel case
- Contents:
- 9 Hexagon sockets: 55: 32, 34, 36, 38, 41, 46, 50, 55, 60mm
- 1 Ratchet: 552
- 2 Extensions: 559/8 (200mm), 559/16 (400mm)
- 1 Flexible head: 554
- 1 Sliding head for T-Handle: 556
- 1 Bar handle: 558

Part No.	Ref
STW96050103	55/9/6N



SOCKET SET - 3/4" DRIVE HEXAGON - 15 PIECES - 55A/10/5

- Stahlwille HPQ (high performance quality) sockets are manufactured from selected tough steel alloys
- Their extremely thin walls and unbelievably high load capacity are simply exemplary
- Stahlwille sockets are equipped with the AS Drive (anti slip drive) profile (up to 38mm)
- This permits high transmission of forces to lands of nuts and bolts without damaging them
- In sturdy sheet steel case
- Contents:
- 10 Bi-Hexagon sockets: 55a: 1-1/16", 1-1/8", 1-1/4", 1-3/8", 1-7/16", 1-1/2", 1-5/8", 1-3/4", 1-13/16", 1-7/8"
- 1 Ratchet: 552
- 2 Extensions: 559/8 (200mm), 559/16 (400mm)
- 1 Sliding head for T-Handle: 556
- 1 Bar handle: 558

Part No.	Ref
STW96054101	55A/10/5



Automotive



SOCKET - SET C PROFILE 3/4" DRIVE - 32 EMAZ

3/4"

- Manually operated sockets with thin walls and knurled base
- CHROME VANADIUM steel- 31CrV3
- Chrome plated
- Contents:
- Insert: C32 EMAZ
- Accessories:
- 3293Z-94 Ratchet
- 3287 Sliding "T" bar
- 3290/200, 3290/400 Extension
- Sockets:
- C32: 27 / 1-1/16", 29 / 1-1/8", 32 / 1-1/4", 33 / 1-15/16", 36 / 1-7/16", 38 / 1-1/2", 41 / 1-5/8", 46 / 1-13/16", 50 / 2", 1/38"
- Supplied in blue powder coated D32 E steel box



Part No.

GED626538



SOCKET - SET 3/4" DRIVE - D32 EMZ

- Manually operated sockets with thin walls and knurled base
- CHROME VANADIUM steel- 31CrV3
- Chrome plated
- Contents:
- Insert: D32
- Accessories:
- 3293Z-94 Ratchet
- 3287 Sliding "T" bar
- 3290/200, 3290/400 Extensions
- Sockets:
- D32: 22, 24, 27, 30, 32, 36, 38, 41, 46, 50mm
- Supplied in blue powder coated D32 E steel box



Part No.

GED628026



Automotive

1"



SOCKET SET - 1" DRIVE 14 PIECE - RT5/772

- Manufactured from chrome vanadium steel
- Hardened and tempered
- Chrome plated for long service life
- Socket ends and square drives are chamfered
- Square drives fitted with spring loaded locking ball for secure fit
- In sturdy metal case
- Contents:
- Bi-Hex sockets: 36, 41, 46, 50, 55, 60, 65, 70, 75, 80mm
- Ratchet
- Extension bars: 200, 400mm
- Sliding T- bar



DIN 3122	DIN 3123	DIN 3124
----------	----------	----------



Part No.	Size
RIC3455	14 Piece



SOCKET SET - 1" DRIVE BI-HEXAGON - 12 PIECES - 60/6/6/882

- Socket made to DIN 3124/ISO 2725-1
- From finest quality steel
- Chrome plated
- In sturdy sheet steel case
- 12 pieces
- Contents:
- 6 Bi-Hexagon sockets: No.60: 36, 41, 46, 50, 55, 60mm
- 1 Ratchet: 882
- 2 Extensions: 859/8 (200mm), 859/16 (410mm)
- 1 Flexible head: 884
- 1 Sliding head for T-Handle: 886
- 1 Bar handle: 888



Part No.	Ref
STW96060101	60/6/6/882



SOCKET SET - 1" DRIVE BI-HEXAGON & HEXAGON - 14 PIECES - 60/8/6/882

- Socket made to DIN 3124/ISO 2725-1
- From finest quality steel
- Chrome plated
- In sturdy sheet steel case
- Contents:
- 4 Bi-Hexagon sockets: No.60: 46, 50, 55, 60mm
- 4 Hexagon sockets: No.60: 65, 70, 75, 80mm
- 1 Ratchet: 882
- 2 Extensions: 859/8 (200mm), 859/16 (410mm)
- 1 Flexible head: 884
- 1 Sliding head for T-Handle: 886
- 1 Bar handle: 888



Part No.	Ref
STW96060103	60/8/6/882

Automotive



COMBINATION TOOL KIT IN POUCH - 15 PIECES

- Handy zip-up carry pouch
- Cushion grip handles
- A general purpose toolkit
- Contents:
 - Combination Pliers 150mm
 - Long nose Pliers 150mm
 - Adjustable Wrench 150mm
 - Precision Screwdrivers
 - Flat 1.4, 2, 2.4, 3mm
 - Phillips PH00, PH1
- Screwdrivers
 - Flat 6 x 100mm
 - Phillips PH2 x 100mm
- Aluminium Handle Junior Hacksaw
- Steel Measuring Tape 3m x 13mm
- Electrical Tester
- Utility Knife



Code	Size
HON9780	15 Pce



COMBINATION TOOL KIT IN POUCH - 18 PIECES

- Handy zip-up carry pouch
- Cushion grip handles
- A general purpose toolkit
- Contents:
 - Hex Key Wrenches 1.5, 2, 2.5, 3, 4, 5, 6, 8, 10mm
 - Combination Pliers 175mm
 - Long Nose Pliers 150mm
 - Adjustable Wrench 200mm
 - Claw Hammer 300gr
 - Screwdrivers
 - Flat 3 x 75, 5 x 75mm
 - Phillips PH0 x 75, PH1 x 75mm
- Electrical tester



Code	Size
HON9784	18 pce



COMBINATION TOOL KIT IN POUCH - 21 PIECES

- Handy zip-up carry pouch
- Cushion grip handles
- A general purpose toolkit
- Contents:
 - Mini Long Pliers 125mm
 - Mini Diagonal Cutting Pliers 125mm
 - Adjustable Wrench 150mm
 - Extension Bar 1/4" x 75mm
 - 1/4" Dr Sockets 6, 8, 9, 10mm
 - Magnetic Socket Handle
 - Precision Screwdrivers
 - Flat 2.4 x 40mm
 - Phillips PH00 x 40mm
- Driver bits
 - Flat 4, 5, 6mm
 - Phillips PH1, PH2
 - Pozi driv PZ1, PZ2
 - Torx T10, T15
 - Hexagon 1/4"



Code	Size
HON9782	21 Pc



COMBINATION TOOL KIT IN POUCH 25 PIECES

- Handy zip-up carry pouch
- Cushion grip handles
- A general purpose toolkit
- Contents:
 - Hex Key Wrenches 1.5, 2, 2.5, 3, 4, 5, 6, 8, 10mm
 - Heavy Duty Utility Knife
 - Mini Diagonal Cutting Pliers 125mm
 - Mini Long Nose Pliers 125mm
 - Combination Pliers 175mm
 - Long Nose Pliers 150mm
 - Diagonal cutting Pliers 150mm
 - Water Pump Pliers 250mm
 - Claw Hammer 300gr
 - Screwdrivers
 - Flat 3 x 150, 6 x 100mm
 - Phillips PH0 x 150, PH2 x 100mm
 - Precision Screwdrivers
 - Flat 2.4 x 40mm
 - Phillips PH00 x 40mm
 - Steel Measuring Tape 3m x 13mm
 - Electrical tester



Code	Size
HON9786	25 pce





TOOL KIT - COMPLETE WITH 1/2" DRIVE SUPER DRIVE SOCKET SET & SPANNERS

- Lockable, die cast aluminium toolbox with chrome plated hinges
- Professional quality tools in the most popular sizes are suitable for most jobs around the workshop or home
- Chrome vanadium steel sockets, spanners and accessories
- Extra space is available under the centre tray
- Lifetime and quality guarantee
- Spare insert trays are available
- Contents:

**DIN
3124**

- 1/2" Ratchet
- 2 Extensions: 125 & 250mm
- 1 Universal Joint
- 1 Sliding T-Bar
- 2 Spark Plug Sockets: 16mm (5/8" E20), 21mm (13/16" E26)
- Ball-pein Hammer 500g
- 6mm Pin Punch
- 10" Locking Plier
- 7 Piece Ball Ended Long Allen Keys
- 10 Screwdrivers:

- 8 x 150, 6 x 150, 6 x 100, 4 x 100, 3, 2 x 75, 6 x 38mm Stubby
- #3 x 150, #2 x 100mm, #1 x 75mm #2 x 38mm Stubby

Code	Size
RIC7985	65 pce

NO RUST DIE-CAST ALUMINIUM CASE



Super-Drive One socket/spanner for every type of bolt!

6	7	8	9	10	11	12	13	14	15	16	17	18	19	20	21	22	23	24	27	30	32
1/4"	9/32"	5/16"	11/32"	3/8"	7/16"	15/32"	1/2"	9/16"	19/32"	5/8"	21/32"	11/16"	3/4"	25/32"	13/16"	7/8"	29/32"	15/16"	1 1/16"	1 3/16"	1 1/4"
E8		E10	E11	E12	E14	E14	E16	E18	E18	E20	E20	E22	E24		E26	E28	E28	E30	E34	E38	E40



TOOL KIT - COMPLETE WITH 1/2" DRIVE BI-HEX SOCKET SET

- Lockable, die cast aluminium toolbox with chrome plated hinges
- Professional quality tools in the most popular sizes are suitable for most jobs around the workshop or home
- Chrome vanadium steel sockets, spanners and accessories
- Extra space is available under the centre tray
- Lifetime and quality guarantee
- Spare insert trays are available
- Contents:

- 1/2" Ratchet
- 2 Extensions: 125 & 250mm
- 1 Universal Joint
- 1 Sliding T-Bar
- 2 Spark Plug Sockets: 16 & 21mm
- 20 Sockets: 8, 9, 10, 11, 12, 13, 14, 15, 16, 17, 18, 19, 20, 21, 22, 23, 24, 27, 30, 32mm
- Ball-pein Hammer 500g
- 6mm Pin Punch
- 10" Locking Plier
- 7 Piece Ball Ended Long Allen Keys
- 18 Spanners: 6, 7, 8, 9, 10, 11, 12, 13, 14, 15, 16, 17, 18, 19, 20, 21, 22, 24mm
- 10 Screwdrivers:

- 8 x 150, 6 x 150, 6 x 100, 4 x 100, 3, 2 x 75, 6 x 38mm Stubby
- #3 x 150, #2 x 100mm, #1 x 75mm #2 x 38mm Stubby

Code	Size
RIC7999	65 pce

NO RUST DIE-CAST ALUMINIUM CASE

**DIN
3122** **DIN
3123** **DIN
3124**





TOOLS FOR 7 DRAWER TOOL TROLLEY - 152 PIECES

TRAY 1

64 Piece 1/4" Profi-Plus Socket Set

6 Point

- 1 - Ratchet handle 145mm
- 3 - Extension bars 50, 100 & 150mm
- 1 - Universal joint
- 1 - Spinner handle 150mm
- 1 - Magnetic socket pick-up
- 1 - Sliding T Bar
- 9 - Hex ball point keys (long pattern) - 1.5, 2, 2.5, 3, 4, 5, 6, 8, 10mm
- 14 - 6pt Flank sockets - 4, 4.5, 5, 5.5, 6, 7, 8, 9, 10, 11, 12, 13, 14mm
- 9 - 6pt Flank deep sockets - 5, 6, 7, 8, 9, 10, 11, 12, 13mm
- 24 - Socket bits (32mm long)



Spot missing tools right away when the RACO® blue shows through

- 3, 4, 5, 6, 7, 8, 10mm
- 4, 5.5, 6.5mm
- PH1, PH2, PH3
- T8, T10, T15, T20, T25,
- PZ1, PZ2, PZ3
- T27, T30, T40

1



29 Piece 1/2" Profi-Plus Socket Set

12 Point

- 1 - Ratchet Handle
- 2 - Extension Bars 125, 250mm
- 1 - Universal Joint
- 1 - Sliding T Bar
- 2 - Spark Plug Spanners - 16, 21mm
- 20 - Sockets - 8, 9, 10, 11, 12, 13, 14, 15, 16, 17, 18, 19, 20, 21, 22, 23, 24, 27, 30, 32mm
- 1 - Powerbar 1/2" Drive
- 1 - Torque Wrench 30-210Nm 1/2" Drive

2



TRAY 2

- 8 - Piece Knife Type Torx Allen Key Set: T9, T10, T15, T20, T25, T27, T30, T40
- 1 - Combination plier 200mm
- 1 - Diagonal Cutting Plier 200mm
- 1 - Long Nose Plier 200mm
- 1 - Waterpump Plier 250mm
- 4 - Circlip Pliers 175mm: 1/5 Straight, 1/5 Bent, O/S Straight, O/S Bent
- 6 - Piece D-Tuf Screwdriver Set:
 - 3,2 x 75, 5 x 100, 5 x 100, 8 x 150mm
 - No. 1 x 75, No. 2 x 100mm
- 5 - Black Tip Screwdrivers:
 - Electrician: 4 x 100mm
 - Mechanics: 6 x 38, 6 x 150mm
 - Philips: 2 x 38, 3 x 150mm
- 1 - Black Shifter 375mm
- 1 - Lockgrip Plier 250mm

3



TRAY 3

- 26 Combination Offset Spanners: 6, 7, 8, 9, 10, 11, 12, 13, 14, 15, 16, 17, 18, 19, 20, 21, 22, 23, 24, 25, 26, 27, 28, 29, 30, 32mm
- 5 Piece Ratchet Spanner Set: 6/8mm, 10/11mm, 13/14mm, 15/17mm, 19/21mm

DIN 3122

DIN 3123

DIN 3124



TOOL TROLLEY (COMPLETE) - 7 DRAWER 153 PIECES

- Durable ball bearing drawer slides
- Lockable
- Heavy duty castors with step brake
- Lifetime and quality guarantee
- Rubber top protector prevents tools damaging the trolley
- Powder coated for durability
- Supplied complete with all tools shown above

TOOLS ONLY

Code	Size
RIC7992	152 pce

Code	Size
RIC7993K	153 pce

Automotive



117 PIECE, 4 DRAWER TOOLCHEST - COMPLETE

- 117 precision manufactured pieces
- Chrome Vanadium with satin finish
- Sockets manufactured from CR-V STEEL to ROCKWELL HARDNESS HRC38-48
- Torque: 1/4" ratchet handle - 62 NM (HRC39) CR-V STEEL
- Torque: 1/2" ratchet handle - 512 NM (HRC39) CR-V STEEL
- Combination spanners manufactured from CR-V STEEL to ROCKWELL HARDNESS HRC39-48
- Pliers manufactured from CR-V STEEL to ROCKWELL HARDNESS HRC38-48 (Cutting blades HRC55-65) with cushion grip handles
- Lifetime warranty
- **Professional Tool Chest:**
- Thickness of steel for tool chest: 0.6mm
- Thickness of steel for drawer: 0.5mm
- Max bearing weight for small drawer: 3kg
- Max bearing weight for medium drawer: 5kg
- Max bearing weight for big drawer: 8kg
- Heavy duty drawer mechanism
- Spare storage drawer
- Fully lockable



TRAY 1



- 11pc 1/4" Dr. 6pt sockets: 4, 4.5, 5, 5.5, 6, 7, 8, 9, 10, 11, 12mm
- 18pc 1/2" Dr. 6pt sockets: 10, 11, 12, 13, 14, 15, 16, 17, 18, 19, 20, 21, 22, 23, 24, 27, 30, 32mm
- 1pc 1/4" Dr. quick-release offset ratchet
- 1pc 1/2" Dr. quick-release offset ratchet
- 2pc universal joints: 1/4" & 1/2" Dr.
- 2pc 1/2" Dr. spark plug sockets: 16 & 21mm
- 2pc 1/4" Dr. extension bars: 50 & 100mm
- 2pc 1/2" Dr. extension bars: 125 & 250mm
- 1pc 1/4" Dr. sliding T-bar
- 1pc 1/2" Dr. sliding T-handle
- 1pc 150mm flexible extension 1pc 1/4" Dr. spinner handle
- 1pc 1/4" bit coupler
- 36pc 25mm screwdriver bits:
- 5pc Phillips: #0, #1, #2 x 2, #3
- 8pc Slotted: 2, 2.5, 3, 4, 5, 5.5, 6, 7mm
- 10pc Star: T8, T9, T10, T15, T20, T25, T27, T30, T40, T45
- 8pc Hex: 2, 2.5, 3, 4, 5, 5.5, 6, 7mm
- 5pc Poz: #0, #1, #2 x 2, #3

TRAY 2



- 18pc Hex key wrenches:
- 7pc Star: T10, T15, T20, T25, T27, T30, T40
- 11pc Hex: 1.27, 1.5, 2.0, 2.5, 3.0, 3.5, 4.0, 4.5, 5.0, 5.5, 6.0mm
- 1pc 160mm diagonal cutting pliers
- 1pc 160mm long nose pliers
- 1pc 180mm combination pliers
- 1pc 200mm water pump pliers
- 1pc 175mm locking grip pliers

TRAY 3



- 5pc combination wrenches: 10, 12, 13, 14, 17mm
- 1pc utility knife
- 8pc cushioned grip screwdrivers:
- 4pc Phillips: #1 x 75, #2 x 38, #2 x 100, #3 x 150mm
- 4pc slotted: 6 x 38, 4 x 75, 5 x 100, 6 x 150mm



Code	Size
PRO1000	117 pce



TOOL KIT - MECHANIC'S - 1/2" DRIVE - C19-1BM-60P - 72 PIECE

- Comprehensive mechanic's toolkit
- Contains sufficient tools for basic repairs
- **TOOLBOX NOT INCLUDED IN SET**

- Can use 1280 or 1281
- Accessories:
 - 50/20.8 Spark Plug Socket
 - 62/250H Adjustable Wrench
 - 143/250 Universal Plier
 - 1987 Sliding "T" Bar
 - 1990-75 Extension
 - 1990-125 Extension
 - 1990-250 Extension
 - 1993U-10T Ratchet
 - 1995 Universal Joint

- Sockets: C19

8-5/16	10-3/8	11	12	13-1/2	14
15-19/32	16-5/8	17	18-11/16	19	21-13/16
22	24-15/16	26-1.	27-1.1/16	29-1.1/8	30-1.3/16
32-1.1/4	7/16AF	9/16AF	7/8AF		

- Allen Key Sockets: IN19

5	6	8	10	12	14
---	---	---	----	----	----
- Spanners: No. 1B

6	7	8	9	10	11	12	13	14	15	16	17	18	19	20	21	22
---	---	---	---	----	----	----	----	----	----	----	----	----	----	----	----	----
- Allen Keys: 42/88M Plastic Holder : 2, 2.5, 3, 4, 5, 6, 8, 10
- Screwdrivers:

150MS	6,5x150	8,0x175	
160PHS	1x80	2x100	3x150
170ELS	3,0x100	4,0x125	6,5x200
STUBBY	5,5x25	2x25	



TOOLS ONLY

Code
GED661627



TOOL KIT - MECHANIC'S - 1/2" DRIVE - C19/22-1BM-10SD - 67 PIECE

- Comprehensive mechanic's toolkit
- Contains sufficient tools for basic repairs
- **TOOLBOX NOT INCLUDED IN SET**

- Can use 1280 or 1281
- Accessories:
 - 50/20.8 Spark Plug Socket
 - 137/250 Grip Plier
 - 143/250 Universal Plier
 - 1987 Sliding "T" Bar
 - 1990-75 Extension
 - 1990-125 Extension
 - 1990-250 Extension
 - 1993U-10T Ratchet
 - 1995 Universal Joint
 - 1997/375 Power Bar

- Sockets: C19

8-5/16	10-3/8	11	12	13-1/2	14
15-19/32	16-5/8	17	18-11/16	19	21-13/16
22	24-15/16	26-1.	27-1.1/16	29-1.1/8	30-1.3/16
32-1.1/4	7/16AF	9/16AF	7/8AF		

- Spanners: No. 1B

6	7	8	9	10	11	12	13	14	15	16	17	18	19	20	21	22
---	---	---	---	----	----	----	----	----	----	----	----	----	----	----	----	----
- Allen Keys: 42/88M Plastic Holder : 2, 2.5, 3, 4, 5, 6, 8, 10
- Screwdrivers:

150MS	6,5x150	8,0x175	
160PHS	1x80	2x100	3x150
170ELS	3,0x100	4,0x125	6,5x200
STUBBY	5,5x25	2x25	



TOOLS ONLY

Code
GED661635



TOOL KIT -WORKSHOP / MECHANIC'S - D19-1BM-60CP - 72 PIECE

- Comprehensive mechanic's toolkit
- Contains sufficient tools for basic repairs
- **TOOLBOX NOT INCLUDED IN SET**

- Can use 1280, 1281 or 1282
- Accessories:
 - 50/20.8 Spark Plug Socket
 - 62/250H Adjustable Wrench
 - 143/250 Universal Plier
 - 1987 Sliding "T" Bar
 - 1990-75 Extension
 - 1990-125 Extension
 - 1990-250 Extension
 - 1993U-10T Ratchet
 - 1995 Universal Joint

- Sockets: D19

8	10	11	12	13	14	15	16	17	19	21	22	23	24	26	27	28
30	32	7/16AF	9/16AF	7/8AF												

- Allen Key Sockets: IN19

5	6	8	10	12	14
---	---	---	----	----	----
- Spanners: No. 1B

6	7	8	9	10	11	12	13	14	15	16	17	18	19	20	21	22
---	---	---	---	----	----	----	----	----	----	----	----	----	----	----	----	----
- Allen Keys: 42/88M Plastic Holder: 2, 2.5, 3, 4, 5, 6, 8, 10
- Screwdrivers:

150MS	6,5x150	8,0x175	
160PHS	1x80	2x100	3x150
170ELS	3,0x100	4,0x125	6,5x200
STUBBY	5,5x25	2x25	



TOOLS ONLY

Code
GED661899



TOOL KIT - MECHANIC'S - 1/2" DRIVE - D19/22-1BM-10SD

REF A-C19/22/ACC (10 Piece) A

Insert: 1280/81-22-ACC

Accessories

50/20.8 Spark Plug Socket
1987 Sliding "T" Bar
1990-75 Extension
1990-125 Extension
1990-250 Extension
1995 Universal Joint
1997/375 Power Bar
Sockets: C19
7/16AF 9/16AF 7/8AF

REF I-D19 (20 Piece) Insert: 1280/81-D19

Accessories

1993U-10T Ratchet
Sockets: D19
8 10 11 12 13 14 15 16 17 19
21 22 24 26 27 28 29 30 32

REF C-1B (27 Piece) Insert: 1280/81-1B

Accessories:

137/250 Grip Plier
143/250 Universal Plier
Metal tray 1280/81
Spanners: No. 1B
6 7 8 9 10 11 12 13 14 15 16
17 18 19 20 21 22
Allen Keys: 42/88M Plastic
Holder
2 2.5 3 4 5 6 8 10

REF 10SD - 10 Screwdrivers (10 Piece)

Insert: (REF N) 1282-SD-PH-STB 1282-SD-MEC-EL

Screwdrivers

150MS 1,2x6,5x150
1,2x8,0x175
160PHS 1x80 2x100 3x150
170ELS 0,5x3,0x100
0,8x4,0x125 1,2x6,5x200
STUBBY 1,0x5,5x25 2x25



TOOLS ONLY

Code

GED661902



TOOL KIT - MECHANIC'S 1/2" & 3/4" DRIVE - C32/19-1BM-60P - 82 PIECE

- Comprehensive mechanic's tool kit
- Contains sufficient tools for basic repairs
- **TOOL BOX NOT INCLUDED IN SET**
- (Can use GED 660949/1281 OR GED 660930/1280)

Inserts:

1281/2 1281/82-1B/62H 1280/81-D19/IN19
1280/81-D19 ACC/SKT
1280/81-D32/6

1282 1282-SD-PH-STB 1282-SD-MEC-EL

Metal Tray:

1281 - 1280/81 - D32 1282 - 1282 - D32

Accessories:

50/20.8 Spark Plug Socket 62/250H Adjustable

Wrench

143/250 Universal Plier 1987 Sliding "T" Bar
1990-75 Extension 1990-125 Extension
1990-250 Extension 1993U-10T Ratchet
1995 Universal Joint 3287/447 Sliding "T" Bar
3290-200mm Extensions 3290-400mm

Extensions

3293U-1/440 Ratchet

Sockets: C19

8-5/16 10-3/8 11 12 13-1/2 14
15-19/32 16-5/8 17 18-11/16 19 21-13/16
22 24-15/16 26-1. 27-1.1/16 29-1.1/8
30-1.3/16 32-1.1/4 7/16AF 9/16AF 7/8AF

C32

1.3/8AF 36-1.7/16
38-1.1/2 41-1.5/8
46-1.13/16 50-2.

Allen Key Sockets:

IN19
5 6 8 10 12 14

Spanners: No. 1B

6 7 8 9 10 11 12
13 14 15 16 17
18 19 20 21 22

Allen Keys:

42/88M Plastic
Holder
2 2.5 3 4 5 6 8 10

Screwdrivers: 150MS 6,5x150 8,0x175

160PHS 1x80 2x100 3x150
170ELS 3,0x100 4,0x125 6,5x200
STUBBY 5,5x25 2x25



TOOLS ONLY

Code

GED662089



TOOL KIT - COMPLETE WITH TOOLBOX - 1282-C19-1BMZ-PL-6SD - 60 PIECE

- Comprehensive tool kit

Toolbox: 1282

Accessories:

137/250 Grip Plier
145/250 Universal Plier
1987 Sliding "T" Bar
1990-75 Extension
1990-125 Extension
1990-250 Extension
1993Z-94 Ratchet
Sockets: C19
8-5/16 10-3/8 11 12 13-1/2 14
15-19/32 16-5/8 17 18-11/16
19 21-13/16 22 24-15/16 26-1.
27-1.1/16 29-1.1/8 30-1.3/16
32-1.1/4

Spanners: No. 1B

6 7 8 9 10 11 12 13 14 15 16 17
18 19 20 21 22

Allen Keys: 42/88M Plastic

2 2.5 3 4 5 6 8 10

Screwdrivers:

150MS 6,5x150 8,0x175
160PHS 1x80 2x100
170ELS 3,0x100 4,0x125

Pliers:

8132/200 JC Telephone
Pliers
8250/200 JC Universal
Pliers
8316/200 JC Side
Cutters



COMPLETE TOOLKIT

Code

GED679232

Automotive



TOOL KIT - COMPLETE WITH TOOLBOX - 1282-MA-1B-D19 - 63 PIECE

- Comprehensive tool kit
- Contents: Toolbox: 5 Compartment sheet metal with robust handle
- Accessories:
 - 1995 Universal joint
 - 2100 Centre punch
 - 1987 Sliding "T" Bar
 - 1990-75 Extension
 - 1990-125 extension
 - 1990-250 Extension
 - 1993U-10T Ratchet
 - 50 / 20.8 mm /13/16 spark plug spanner
 - 8601 / 500 Ballpein hammer
- Sockets :
 - BI-HEX: 8,10,11,12,13,14,15,16,17,19,21,22,24,26,27,29,30,32
- Spanners :
 - Combination : 6,7,8,9,10,11,12,13,14,15,16,17,18,19,20,21,22,24
- Allen keys:
 - 42/88M Plastic holder: 2,2.5,3,4,5,6,7,8
- Screwdrivers :
 - 150MS 1.2 x 6.5 x150mm 1.2 x 8 x 175 mm
 - 160PH 420N 1 x 80 mm 2 x 100mm 3 X 150mm
 - 170ELS 0.5 x 3.0 x 100 mm 0.8 x4.0 x 125mm 1.2 x 6.5 x 200mm
 - 440N 1 x 5 .5 x25
 - Stubby : PHS441N 2 x 25mm



COMPLETE TOOLKIT Code
GED679275



SHEET METAL CABINET - 1401 PRO - 76 PIECE

- Ideal for professional workshop
- Rigid sheet metal structure with precision CNC punched pegboard
- 3 easy slide drawers incorporating extra strong ball bearing slider mechanism
- 1 moveable tray
- Spanner & screwdriver rack
- Assortment of moveable hanging hooks for maximum flexibility
- Lockable
- Phosphated to prevent corrosion
- Blue powder coated
- Cabinet accessories:
 - 30 x Plastic holders with pins; 1 x Tool Rack
 - 17pin; 1 x Double Storage Tray; 1 x Screwdriver – 6 piece; 1 x Punch Holder



- CONTENTS:
- 50/20.8 Spark plug socket
 - 60P/250 Adjustable Wrench
 - 137/250 Grip plier
 - 143/250 Universal Plier
 - 225/250 Pipe Wrench
 - 1987 Sliding "T" bar
 - 1990/75, 1990/125, 1990/250 Extension
 - 1993Z-94 Ratchet
 - 1995 Universal Joint
 - 8531/300 Tin Snips
 - 8601/500 Ball Pein hammer
- Sockets:**
- C19 : 8-5/16", 10-3/8", 11, 12, 13-1/2", 14, 15-19/32", 16-5/8", 17, 18-11/16", 19, 21-13/16", 22, 24-15/16", 26-1", 27-1 1/16", 29-1 1/8", 30-1 3/16", 32-1 1/4", 7/16" AF, 9/16" AF, 7/8" AF
- Allen Key sockets:**
- IN19 : 5, 6, 8, 10, 12, 14mm
- Spanners:**
- 1B : 6, 7, 8, 9, 10, 11, 12, 13, 14, 15, 16, 17, 18, 19, 20, 21, 22mm
- Allen keys:**
- 42/88m Plastic Holder : 2, 2.2, 3, 4, 5, 6, 8, 10mm
- Screwdrivers:**
- 150MS 6.5 x 150, 8.0 x 175,
 - 160PHS 1 x 80, 2 x100, 3 x150
 - 170ELS 3.0 x 100, 4.0 x 125, 6.5 x 200
 - Stubby 5.5 x 25, No 2 x 25

Code

GED661163

COMPLETE TOOLKIT



SHEET METAL TROLLEY - CLASSIC - 1581 - 76 PIECE

- Ideal for professional workshop
- Rigid sheet metal cabinet structure with pegboard back
- 6 Standard and 1 deep easy slide drawers incorporating extra strong ball bearing slider mechanisms
- Working platform with 3 compartments for small parts, raised edges
- Central drawer locking mechanism
- Two swivel castors (one with safety brake) for maximum mobility & safety
- Handle for easy manoeuvrability
- Load capacity 300Kg
- Phosphated
- Blue and grey powder coated



Code

GED661306

- CONTENTS:
- Inserts:** 1280/81-B60, 1280/81-D19/IN19, 1280/81-D19 Acc/Skt
- 1280/81-SD-PH-STB, 1280/81-SD-MEC-EL, 1280/81-PL/137/36
- 1581 Filler
- Accessories:**
- 36/1 OIL Filter Strap Wrench
 - 50/20.8 Spark plug socket
 - 60P/250 Adjustable Wrench
 - 137/250 Grip plier
 - 143/250 Universal Plier
 - 1987 Sliding "T" bar
 - 1990/75, 1990/125, 1990/250 Extension
 - 1993U-10T Ratchet
 - 1995 Universal Joint
 - 8000-A2 Circlip Plier
 - 8000-J2 Circlip Plier
 - 8132-200 JC Telephone Plier
 - 8250-200 JC Combination Plier
 - 8316-200 JC Side Cutter

- Sockets:**
- C19 : 8-5/16", 10-3/8", 11, 12, 13-1/2", 14, 15-19/32", 16-5/8", 17, 18-11/16", 19, 21-13/16", 22, 24-15/16", 26-1", 27-1 1/16", 29-1 1/8", 30-1 3/16", 32-1 1/4", 7/16", 9/16", 7/8"
- Allen Key sockets:**
- IN19 : 5, 6, 8, 10, 12, 14mm
- Spanners:**
- 1B : 6, 7, 8, 9, 10, 11, 12, 13, 14, 15, 16, 17, 18, 19, 20, 21, 22mm
- Allen keys:**
- 42/88m Plastic Holder: 2, 2.2, 3, 4, 5, 6, 8, 10mm
- Screwdrivers:**
- 150MS 6.5 x 150, 8.0 x 175,
 - 160PHS 1 x 80, 2 x100, 3 x150
 - 170ELS 3.0 x 100, 4.0 x 125, 6.5 x 200
 - Stubby 5.5 x 25, No 2 x 25



COMPLETE TOOLKIT

3/8"



TORQUE WRENCH - 3/8" DRIVE - RT6/753GA

- Raco micrometer adjustable torque wrenches are fast and accurate to any torque value within the capacity range of the wrench
- Precision torque is indicated mechanically by an audible sound or click signals
- Releases and resets automatically
- Rotating micrometer adjustment for quick torque setting
- Locking device to prevent accidental slipping of setting
- Can be used on either left or right handed nuts and bolts with certified accuracy
- Rugged construction with precision parts, manufactured under careful quality control assuring long, trouble free service across a wide variety of torquing applications
- Guaranteed well balanced
- Micrometer model accurate within 3% in right direction
- Supplied in blow case



Part No.	Torque Range
RIC6038	21-119Nm



TORQUE WRENCH - 3/8" DRIVE - 800020

- Invaluable for use on low torque applications, the torque setting is obtained by rotating the knurled knob on the end of the handle
- Push through square drive for tightening or releasing left and right hand threads
- With calibration certificate



Code	Range Nm	Range LBF.IN	Length
SYK800020	4-20Nm	40-180	210mm



TORQUE WRENCH - 3/8" DRIVE - 800060

- A high quality, professional wrench which is particularly suitable for light engineering machinery, motorcycles and light vehicle applications
- Slim body in durable satin chrome
- Comfortable nylon handle with positive locking knob
- Complies to BSEN 26789 and ISO 6789



Code	Range Nm	Range LBF.FT	Length
SYK800060	8-60Nm	5-45	305mm



TORQUE WRENCH - 3/8" DRIVE - 800100

- For general engineering, workshop, construction, aero, marine and light vehicle applications



Code	Range Nm	Range LBF.FT	Length
SYK800100	20-100Nm	15-80	356mm

Automotive

1/2"



TORQUE WRENCHES - 1/2" DRIVE

- Raco micrometer adjustable torque wrenches are fast and accurate to any torque value within the capacity range of the wrench
- Precision torque is indicated mechanically by an audible sound or click signals
- Releases and resets automatically
- Rotating micrometer adjustment for quick torque setting
- Locking device to prevent accidental slipping of setting
- Can be used on either left or right handed nuts and bolts with certified accuracy
- Rugged construction with precision parts, manufactured under careful quality control assuring long, trouble free service across a wide variety of torquing applications
- Guaranteed well balanced
- Micrometer model accurate within 3% in right direction
- Supplied in blow case



Part No.	Torque Range	Ref.
RIC6042	42-210Nm	RT6/754GA
RIC6045	70-350Nm	RT6/756GA



TORQUE WRENCH - 1/2" DRIVE - 800101

- For general engineering, workshop, construction, aero, marine and light vehicle applications



Code	Range Nm	Range LBF.FT	Length
SYK800101	20-100Nm	15-80	356mm



TORQUE WRENCH - 1/2" DRIVE - 800200

- For medium/heavy engineering, workshop, construction, aero, marine and commercial vehicle applications



Code	Range Nm	Range LBF.FT	Length
SYK800200	40-200Nm	30-150	455mm



TORQUE WRENCH - 1/2" DRIVE - 800300

- For medium/heavy engineering, workshop, construction, aero, marine and medium/heavy commercial vehicle applications



Code	Range Nm	Range LBF.FT	Length
SYK800300	60-300Nm	45-220	570mm



TORQUE WRENCH - 1/2" DRIVE - 800330

- Similar features to 800300, but with increased torque range and length
- Push through square drive to allow tightening of both left and right hand threads



Code	Range Nm	Range LBF.FT	Length
SYK800330	60-300Nm	45-250	690mm

1/2"



TORQUE WRENCH - TOTCOFIX-K - 1/2" DRIVE - 4550-20

- Features:
- Adjustable torque wrench with a square drive and integrated ratchet head function
- For bi-directional tightening
- Interchangeable mushroom head square drive with ball locking mechanism
- In accordance with DIN EN ISO 6789

- Lever breaking mechanism with a castor guarantee tactile impulse and audible actuation signal
- Actuation accuracy: $\pm 3\%$ of the scale set to torque
- Double scale Nm and lbf.ft behind window with magnifying effect



Code	Size Nm	Size lbf.ft
GED760161	20-200Nm	15-150



TORQUE WRENCH - TOTCOFIX-K - 1/2" DRIVE - 4550-40

- Features:
- Adjustable torque wrench with a square drive and integrated ratchet head function
- For bi-directional tightening
- Interchangeable mushroom head square drive with ball locking mechanism
- In accordance with DIN EN ISO 6789

- Lever breaking mechanism with a castor guarantee tactile impulse and audible actuation signal
- Actuation accuracy: $\pm 3\%$ of the scale set to torque
- Double scale Nm and lbf.ft behind window with magnifying effect



Code	Size Nm	Size lbf.ft
GED767433	75-400Nm	55-300

3/4"



TORQUE WRENCH MOTORQ - 800399

- Push through square drive to allow tightening of both left and right hand threads



Code	Range Nm	Range lbf.ft	Length	Drive
SYK800399	80-400	60-300	683mm	3/4"



TORQUE WRENCH HEAVY DUTY MOTORQ - 800400

- These heavy duty, robust back-break type wrenches are fitted with left and right hand 36 tooth ratchet head and feature easy adjustment by means of a graduated scale at handle end of tool

- Instant collapse of mechanism seen and felt on reaching pre-set loading
- Rugged construction to withstand heavy usage
- Push through square drive to allow tightening of both left and right threads



Code	Range Nm	Range lbf.ft	Length	Drive
SYK800400	150-700	100-500	1150mm	3/4"



TORQUE WRENCH MOTORQ - 800500

- These heavy duty, robust back-break type wrenches are fitted with left and right hand 36 tooth ratchet head and feature easy adjustment by means of a graduated scale at handle end of tool

- Instant collapse of mechanism seen and felt on reaching pre-set loading
- Rugged construction to withstand heavy usage
- Push through square drive to allow tightening of both left and right threads



Code	Range Nm	Range lbf.ft	Length	Drive
SYK800500	300-1000	200-750	1475mm	3/4"

Automotive

TORQUE WRENCH MOTORQ - 800550

- These heavy duty, robust back-break type wrenches are fitted with left and right hand 36 tooth ratchet head and feature easy adjustment by means of a graduated scale at handle end of tool
- Instant collapse of mechanism seen and felt on reaching pre-set loading
- Rugged construction to withstand heavy usage
- Push through square drive to allow tightening of both left and right threads



Code	Range Nm	Range lbf.ft	Length	Drive
SYK800550	700-1500	500-1000	1470mm	1"



TORQUE WRENCH - SERVICE MANOSKOP - 730

- Torque Wrenches with tool carrier for inter changeable insert tools
- Cut-out with quick release safety lock (size 5-65) dual signal, rapid adjustment (size 2-65)
- Robust steel tube completely encloses all working parts
- Any force applied to the tool after the "click" or applied in opposite direction to current function – e.g. forcible loosening of a jammed screw - does not act on the trigger mechanism and cannot cause damage to it
- Reversible insert tools allow anti-clock wise operation
- Deviation of indication $\pm 4\%$. With certificate

Code	No	Size Nm	Fitting Size
STW50180002	730/2	4-20Nm	9x12mm
STW50180004	730/4	8-40Nm	9x12mm
STW50180005	730/5	6-50Nm	9x12mm
STW50180010	730/10	20-100Nm	9x12mm
STW50180012	730/12	25-130Nm	14x18mm
STW50180020	730/20	40-200Nm	14x18mm
STW50180040	730/40	80-400Nm	14x18mm



TORQUE WRENCH - SERVICE MANOSKOP - 730N

- Registered design
- Clicking torque wrench with mount for interchangeable insert tools, rapid, accurate setting using QuickSelect action adjuster, with with QuickRelease safety lock, double stop signals
- Twin scales with colour coded Nm/ft/lb markings and long term repeated accuracy
- Measuring element is only under load while force is being applied, no need for manual re-set to zero
- All sensitive components are protected by the sturdy housing
- 2 component handle with its ergonomically designed green softer layer is resistant to oils, grease, fuels, brake fluids, and Skydrol
- Any force applied to the tool after the "click" or applied in opposite direction to the current function – e.g. forcible loosening of a jammed screw – does not act on the trigger mechanism and cannot cause damage
- Swap over inserts can also be used to apply torque in an anticlockwise direction
- Deviation of indication $\pm 3\%$. With certificate

Code	No	Size Nm	Fitting Size
STW50181002	730N/2	2-20Nm	9x12mm
STW50181010	730N/10	20-100Nm	9x12mm
STW50181020	730N/20	40-200Nm	14x18mm
STW50181040	730N/40	80-400Nm	14x18mm



RATCHET - INSERT TOOL - 735

- Used with torque wrench
- Reversible
- 60 teeth
- Maximum continuous loads of ratchet insert tools are limited to:
735/5 and 735/10 – 100Nm
735/20 – 300Nm
735/40 – 650Nm
- Limits must not be exceeded when these insert tools are used with torque wrenches of larger capacity



Part No.	Size	Drive	Ratchet Fitting
STW58250005	5	3/8"	9 x 12mm
STW58250010	10	1/2"	9 x 12mm
STW58250020	20	1/2"	14 x 18mm
STW58250040	40	3/4"	14 x 18mm



RATCHET - INSERT TOOL - 725/4

- Used with torque wrench
- Reversible
- 22 teeth
- Maximum continuous loads of ratchet insert tools are limited to:
725/4 – 40Nm
- Limits must not be exceeded when these insert tools are used with torque wrenches of larger capacity



Part No.	Size	Drive	Ratchet Fitting
STW58254004	4	1/4"	9 x 12mm



INSERT TOOL - OPEN ENDED - 731/40

- Uses QR system
- Use on all standard Stahlwille Torque wrenches
- Chrome plated



Part No.	Size	Ratchet Fitting
STW58214017	17mm	14 x 18mm
STW58214019	19mm	14 x 18mm
STW58214022	22mm	14 x 18mm
STW58214024	24mm	14 x 18mm
STW58214030	30mm	14 x 18mm
STW58214032	32mm	14 x 18mm



INSERT TOOL - SQUARE DRIVE

- Uses QR system
- Use on all standard Stahlwille Torque wrenches
- Chrome plated



Part No.	Ref.	Size	Ratchet Fitting
STW58240010	734/10	1/2"	9 x 12mm
STW58240020	734/20	1/2"	14 x 18mm
STW58240040	734/40	3/4"	14 x 18mm



TORQUE WRENCH GAUGE ANGLE 1/2" DRIVE

- Vehicle manufacturers have adopted torque tightening procedures which also involve the turning of a torqued fastener through a further angular movement on applications such as cylinder head bolts, big end bearings, main bearing bolts, fly wheel bolts etc
- These angular gauges have an oil resistant and clearly graduated, non-reflective surface and an adjustable reaction arm which can be set and fixed against the adjacent component to prevent the scale turning
- 1/2" Square Drive Male and Female



Code

SYK800700



TORQUE WRENCH MULTIPLIER 800600

- Single stage epicyclic gears, producing a 5:1 ratio multiplication ratio
- Used with conventional torque wrenches for heavy-duty applications
- Supplied with reaction bars
- In plastic storage case
- Compact, 5:1 torque multipliers for tightening and releasing nuts and bolts
- Gear Train: Single stage epicyclic
- Velocity Ratio: 5.33 to 1
- Multiplication Factor: 5 to 1
- Efficiency: 94% (Approx)



Code	Max Input	Max Output	Input Drive	Output Drive
SYK800600	340Nm	1300Nm	32mm AF Male Hex x 1/2" Square Drive	3/4" Sq Drive



TORQUE WRENCH MULTIPLIER 800655

- Single stage epicyclic gears, producing a 5:1 ratio multiplication ratio
- Used with conventional torque wrenches for heavy-duty applications
- Supplied with reaction bars
- In plastic storage case
- Compact, 5:1 torque multipliers for tightening and releasing nuts and bolts
- Gear Train: Single stage epicyclic
- Velocity Ratio: 5.33 to 1
- Multiplication Factor: 5 to 1
- Efficiency: 94% (Approx)



Code	Max Input	Max Output	Input Drive	Output Drive
SYK800655	540Nm	2700Nm	36mm AF Male Hex x 3/4" Square Drive	1" Sq Drive



DIGITAL CLAMP METER - AC (400A)

- This is a hand held digital clamp meter offering current measurements whilst clamped over a conductor
- Jaw Size 26mm
- Compact
- Diode
- Continuity
- Relative zero
- Data hold
- Carrying pouch



Technical Specifications:

Model	TBM3030
AC Current	40,400A
DC Voltage	400m,4,40,400,600v600V
AC Voltage	4,40,400,600V
Resistance	400,4K,40K,400K,4M,40MΩ
Frequency	5HZ to 100KHZ
Capacitance	500n,5μ,50μ,500μ,3000μF

Code

BTH0630



ANALOGUE MULTIMETER

- This is a hand held electricians analogue multimeter
- Max 10A DC current
- Battery check
- Fuse and diode protection
- Diode and transistor test
- 0Ω adjustment
- Power source 2 x 105V AA batteries, 9V Battery



Technical specifications:

Model	T2010BA
DC Current	50μ,2.5,250m/10A
DC Voltage	0.1,2.5,10,50,250,1000V
AC Voltage	10,50,250,1000V
Resistance	x1,x10,x1k,x10kΩ,(200MΩ)
Decibels	-10 to 62db
Fuse	0.5A,250V (5x20)mm

Code

BTH0640



DIGITAL POCKET MULTIMETER

- This is a pocket size hand held digital multi meter
- Low cost
- 3 1/2 Digit LCD
- Low power consumption
- DC Current (200mA)
- Integral leads
- Continuity
- Power source 12V E23A (Multibatt)



Technical Specifications:

Model	T7290
DC Voltage	2,20,200,300V
AC Voltage	200,300V
DC Current	200mA
Resistance	2K,20K,200K,200
Diode	1.0±0.6mA3.2Vmax

Code

BTH0660



ELECTRICIAN'S DIGITAL MULTIMETER

- Hand held electricians digital multimeter
- Large display
- Temperature
- Data hold
- Capacitance
- Diode
- Continuity
- Temp Bead Probe
- Power source 9V Battery



Technical Specifications:

Model	T235H
A C Current	200mV,20A
D C Current	20mV,200mV,20A
A C Voltage	20V,200,750V
D C Voltage	200mV,2mV,20,200,1000V
Resistance	200,20K,200K,20MΩ,200MΩ
Capacitance	20nf,2uf,200μF
Temperature	-40°C to 1000° C

Code

BTH0680



HOBBYIST DIGITAL MULTIMETER

- Hand held hobbyist digital multimeter
- Low cost
- Temperature
- Diode test
- Continuity
- Temp Bead Probe
- Power source 9V Battery



Technical Specifications:

Model	T2400TH
D C Current	200μ,2m,20m,200m,10A
AC Voltage	200,600V
D C Voltage	200m,2,20,200,600V
Resistance	200,2K,20K,200K,20MΩ
Temperature	-20° C to 750° C K-type
	0° C to 40° Built in sensor
	Buzzer Sound below 20Ω
Continuity	
Diode	2.8V max

Code

BTH0730



DIY DIGITAL MULTIMETER

- Compact hand held DIY digital multimeter
- Low cost
- Temperature
- Continuity
- Diode
- Data hold
- K-Type Thermocouple
- Power source 9V Battery



Technical Specifications:

Model	T835
D C Current	200μ,2m,20m,200m,10A
A C Voltage	200,600V
D C Voltage	200,2,20,200,600V
Resistance	200,2K,20K,200K,20MΩ
Temperature	-20° C to 750° C

Code

BTH0740



TESTER - ELECTRICAL AC/DC RT9/168B

- General purpose tester for hundreds of electrical application across AC and DC ranges
- Twin lead, 4-way designed for checking 110-460 Volts AC/DC
- Check for current, DC polarity, frequency and polyphase line
- Can be used to test fuses, spark plugs etc.



Code

RIC4300

Size

4 Way



TESTER - HIGH CIRCUIT - RT9/165B

- A high circuit electrical tester, precision built for testing 6 - 24 volt DC systems
- Solid brass body, chrome plated plus a powerful neon built-in light
- Insulation piercing contact point with protective brass screw cap
- Complete with 750mm insulated cable and alligator clip



Code

RIC4320

Rating

6-24V



TESTER - MULTI-FUNCTIONAL - RT9/152B

- This is a handy multi-functional cordless tester that checks correct functionality of domestic electrical appliances, bulbs, switches, relays, general wiring, fuses and transformers
- Also used for testing live, neutral and earth terminals in power outlets
- Tests polarity in batteries and semi-conductors
- Manufactured to German GS specifications
- One piece moulding is fully insulated for maximum safety
- Supplied with plain slot blade and pocket clip
- Uses two batteries - included



Code	Rating
RIC4330	12-440V AC



TESTER - CIRCUIT VOLTAGE - RT9/167B

- A popular tester with three long lasting indicators
- Widely used for household, hobby, electronics and engineering
- Measuring range 120/240/440V AC and 150/300/500V DC
- Insulated blades and handles moulded in one piece for maximum safety
- Point-tipped blades



120/220/400 Volt AC
150/300/500 Volt DC

Code
RIC4350



TESTER - VOLTAGE CONTINUITY - RT9/171B

- A quality tester for voltage continuity and polarity
- Perfect for solving numerous problems around the home or workshop
- LED's allow you to check polarity at a glance
- Test semi-conductors for polarity
- Powered by a 12 volt battery
- Features 4 LED's, 6 - 50V DC and one long lasting indicator for voltage reading at 120 - 400V AC/DC
- Continuity: 0 - 20K



Code
RIC4314



TESTER - ELECTRONIC - RT9/174B

- A tester suitable for low voltage domestic and automotive power circuits
- Tester utilises LED's to show correct values on a multi-stage display
- For Direct Current the (+/-) LED indicates the polarity
- Impact resistant ABS plastic housing for maximum operator safety



120/220/400 Volt AC
150/300/500 Volt DC

Code
RIC4315



TESTER - AUTO RT9/173B

- 3 - 48 volt for live direct current
- For troubleshooting in cars and boats
- Fitted with crocodile clamps for clamping to chassis
- 2 LED's which indicate voltage and polarity (±) at place being tested
- Can also measure on insulated cables
- With probe and one slot where the insulated cable is placed
- Size of the voltage tester makes it possible to measure cable groups and other cable
- Impact resistant ABS plastic housing for maximum operator safety



Code	Rating
RIC4348	3-48V DC



TESTER - CIRCUIT - 12905

- For car electricians 6-12 and 24 volt
- Pointing probe, cover cap, connecting lead with alligator clip



Code	Length
STW77380001	120mm



GENERAL PURPOSE VOLTAGE TESTER TCV3

- Hand held voltage tester
- AC/DC Voltage 6, 12, 24, 50, 120, 230, 400V
- Polarity LED lights when DCV is measured
- LED indication
- No Batteries
- Frequency range 0 - 60hz



Code	Size
BTH0770	6-400V



ELECTRICIAN'S SCREWDRIVER SET 1000V WITH TESTER

- 7 piece Insulated set
- Burnished chrome blades
- Sheathed for safety
- Suitable for live work to 1000Volts
- Includes electric tester
- Convenient carry case
- Sizes:
 - Slotted: 3.5 x 75mm
 - 4 x 100mm
 - 5.5 x 125mm
 - Phillips: 0 x 75
 - 1 x 100
 - 2 x 100
 - Electric tester: 4 x 100



Code	Size
HON7810	7 Piece

Automotive



BATTERY HYDROMETER

- Large 212mm long glass filler tube with 75mm rubber bulb and long flexible tip
- Easy-to-read precision calibrated and colour coded glass float
- Heavy gauge glass components
- Operates on specific gravity of fluid

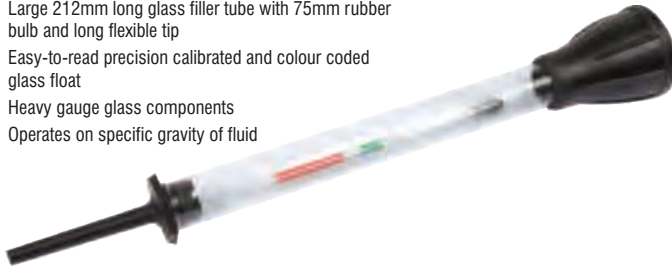

Code	Size
RIC0430	212mm



FLUID REFRACTOMETER TESTER 032010

- This multi-purpose tool, tests coolant, battery acid and screen wash using an optical prism test technique
- Coolant - tests both propylene and ethylene based anti-freeze coolant solutions and determines freezing point
- Battery acid - indicates the specific gravity of the battery electrolyte
- Screen wash - shows the freezing point of screen wash fluids
- Freezing point shown in °C
- Spare Part 032017 Spare Lens Cover



Code
SYK032010



ANTI-FREEZE TESTER - R8/111B

- Large 212mm long glass filler tube with 75mm rubber bulb and long flexible tip
- Easy-to-read precision calibrated and colour coded glass float
- Heavy gauge glass components
- Operates on specific gravity of fluid



Code	Size
RIC4290	212mm



ANTI-FREEZE TESTER 032000

- A quality instrument used to ascertain the volume percentage of ethylene glycol based coolants in an engine cooling system
- It works by showing the lowest temperature in °C to which the cooling system is protected



Code
SYK032000



COOLING SYSTEM TESTER 331595

- Contains the 14 most popular system adaptors that provide extensive coverage for both popular and less popular models for cars and LCV's
- Hand pump with pressure gauge
- Quick-connect hose for system adaptors
- Wide application coverage



Code
SYK331595



CAR COOLING SYSTEM TESTER 331900

- 031901 pump, gauge and hose assembly
- Expansion Plugs nos. 1, 2 & 3
- Safety retaining clamp
- Thermometer
- Special bayonet connector for Japanese applications
- Optional extra: 031915 Stepped Expansion Plug for Mercedes



Code
SYK331900



SUPER COOLING SYSTEM TESTER 331890

- 031801 hand pump unit
- Single and double-ended hose assemblies with standard bayonet fittings
- Threaded system connectors M45, M52
- Threaded cap adaptors M45, M52
- Kit contents, additional connectors and adaptors



Code
SYK331890

COOLING SYSTEM PLANT TESTER 331905

- 031930 Airline Adaptor and Gauge Assembly
- Expansion Plugs nos. 3 & 4
- Safety retaining clamp
- Thermometer



Code

SYK331905

OIL PRESSURE TESTER 314700

- Helps to diagnose worn oil pumps & engines
- Faulty oil pressure switches and warning indicators
- Large, shock protected easy to read dual scale gauge for accurate oil pressure checks
- Permanently oil primed, long flexible hose enables access to difficult to reach oil switch ports
- Small profile, quick coupling adaptors with built in shut-off valve for fast, secure connection
- Complies with DIN16005, DIN 16063 and BS1780
- Scale 0-10 bar, 0-150 PSI



Code

SYK314700

COMPRESSION TESTER SET 314003

- Comprehensive kit based on 314000 Petrol Compression Tester for vehicles with M10, M12, M14 and M18 spark plug threads
- Complete with extensions, thread chasers and service kit



Code

SYK314003

COMPRESSION TESTER - DIESEL 314200

- Comprehensive test kit for both direct and indirect diesel injected engines
- Checks engine compression under cranking conditions
- Enables cylinder access through dummy injector and glowplug adaptors
- Built in pressure relief valve enables repeat tests without dismantling
- Gauge to DIN16005, BS1780 standards



Code

SYK314200

COMPRESSION TESTER 314000

- Large, shock protected, easy to read dual scale gauge for accurate checks 0-20 bar
- Quick and easy to connect dual threaded coupling to M14 and M18 spark plug ports
- Pressure relief valve enables repeated cylinder testing without removing the gauge
- Flexible rubber hose for easy access
- DIN16005, DIN16063 and BS1780



Code

SYK314000

Length

305mm

Gauge Diam.

83mm

TENSION BELT GAUGE 316600

- For accurate tensioning of timing belts, minimising the risk of premature failure due to incorrect belt tension
- Features remote gauge for ease of access, with oil filled piston
- Gauge scale in kg as recommended by vehicle manufacturers, supplied with calibration strip
- Suitable for use on all timing belts, V belts, industrial belts up to 12mm thick



Code

SYK316600

SONOSCOPE 323700

- A super-sensitive sound detector with a built-in diaphragm which amplifies noise to diagnose many vehicle problems
- Including: noisy water pumps and wheel bearings
- Faulty alternator/power steering, pump/air conditioning compressor bearings, camshaft and crankshaft knocks, noisy tappets etc
- Robust metal and plastic construction with 550mm hose and 290mm probe



Code

SYK323700

MECHANIC'S STETHOSCOPE - 12705

- Steel probe
- Plastic handle and sound tubes



Code

STW74060001

GROZ LEVER GREASE GUN - HEAVY DUTY
tools to trust

- Top of the line grease gun for extra heavy duty use
- Suction cartridge, fuller pump loading.
- Lever operated - 10000 PSI / 690 Bar - short stroke
- Powder coated finish
- Incorporating a bulk loader and air bleeder valve
- Variable stroke feature for ease of use in confined spaces.
- Complete with 150 mm steel extension, 300 mm flexible hose and 4 jaw coupler with ball check



Code	Capacity
GRO2200	500 cm ³ Suction Fill

GROZ LEVER GREASE GUN - STANDARD DUTY
tools to trust

- Hardworking entry level model, designed for use in general lubrication and daily maintenance work
- Head incorporates single vent hole with block nut
- Air release achieved through half turn of the head assembly
- Durable powder coated finish
- Complete with 150 mm steel extension and 4 jaw coupler with ball check



Code	Capacity
GRO2202	500 cm ³ Hand Fill

GROZ PISTOL GREASE GUN - VARIO
tools to trust

- Multiple loading: 450g grease cartridge, bulk fill, hand fill or filler pump
- Complete with 300 mm high pressure grease hose and professional 4 jaw coupler
- Ergonomic one hand operation
- Unique variable stroke mechanism for both high volume and high pressure applications (high volume for faster greasing and high pressure for use in cold weather)
- Delivers up to 0.84g/stroke (more than 1.1/2 times more than other guns)
- Solid 11mmØ piston for more grease per stroke
- Robust aluminium die cast grease gun head with bulk filler



Code	Capacity
GRO2234	450g

GROZ PISTOL GREASE GUN
tools to trust

- One hand operation
- 5000 PSI / 345 Bar
- T-grip handle with textured zinc plated barrel
- Professional 4 jaw ball-check coupler
- Complete with a 100mm steel extension



Code	Capacity
GRO2250	500 cm ³ Bulk Fill

GROZ MINI PISTOL GREASE GUN
tools to trust

- One hand operation pistol grip
- 3500 PSI / 249 Bar
- Zinc plated finish with 100 mm extension
- Professional 4 jaw ball-check coupler (has 2 discharge ports - straight and right angle)



Code	Capacity
GRO2155	120g Suction Fill

GROZ PUSH TYPE GREASE GUN
tools to trust

- Push type grease gun
- 1000 PSI / 69 Bar
- Capacity 30 g
- Use with bulk grease only
- Fitted with universal connector - adapts to most grease fittings
- Powder coated steel body



Code	Capacity
GRO2230	30g

GROZ HOSE - HEAVY DUTY

- Flexible, 225 mm grease hose
- Working pressure 5800 PSI / 400 Bar
- Burst pressure 13775 PSI / 950 Bar
- Used primarily with grease control valves
- For hand and air operated Grease Guns



Code	Size
GRO2140	225mm

GROZ HOSE - STANDARD DUTY

- Flexible, 300 mm grease hose
- Working pressure 3500 PSI / 240 Bar
- Burst pressure 11600 PSI / 800 Bar
- For hand operated grease guns only



Code	Size
GRO2220	300mm

GROZ GREASE CONTROL VALVE - PROFESSIONAL

- Premium quality grease control valve for use with power operated equipment
- Provides continuous grease flow with trigger fully depressed
- Steel construction provides durability and long service life
- Ergonomically designed pistol handle
- Available as valve only (as shown) or fitted with a 360° 'Z' swivel (GRO2214)
- Comes complete with 150mm steel extension and heavy duty coupler
- Threaded 1/8" BSPT (F) x 1/8" BSPT (F)



Code
GRO2185

GROZ OIL SUCTION GUN

- A rugged gun designed to extract oils out of hard to reach gearboxes, differentials, transfer boxes etc.
- Deluxe lip seal provides maximum suction
- Complete with 300mm clear flexible vinyl hose
- Knurled banding for better grip
- Powder coated finish
- Fully serviceable, needs no priming
- Suitable for non corrosive liquids



Code	Capacity
GRO2240	500ml

GROZ TRANSFER GUN

- The easiest and safest way to transfer fluids
- Dual direction operation
- Allows for the transfer of fluids from one container to another in a single stroke of the gun
- Eliminates manual contact with the fluid
- Construction allows for use with a variety of oils, fuel, oils, petrol, brake fluid, antifreeze etc.
- Transfer gun comes complete with 1,2m clear vinyl hose for each valve



Code	Capacity
GRO2243	350ml

GROZ LEVER ACTION BARREL PUMP - HEAVY DUTY

- Engineered for heavy duty applications
- All seals and packing are hi-nitrile rubber, with steel piston and foot valves
- Fits 50 and 205 litre barrels and comes complete with curved metal spout and telescopic suction tube with two bungs (1 1/2" and 2")
- Can be used with most oil based fluids
- Not recommended for any acid, solvents, antifreeze or water based fluids



Code	Delivery
GRO3280	300ml / Stroke

GROZ **BUCKET GREASER**
tools to trust

- Quick volume greasing pump constructed from heavy-duty cast iron
- High volume, high pressure grease pump
- Pump includes special valve for air bleeding
- Comes complete with 10 kg built in steel grease bucket
- Uses low cost bulk grease & 10 kg capacity allows complete greasing in a single fill in most applications
- Comes complete with 2 meters of high pressure rubber hose, fitted with steel connector and coupler
- Delivers 9 gms/stroke or 1 oz. in less than 10 strokes at pressures up to 2000 PSI (138 BAR)

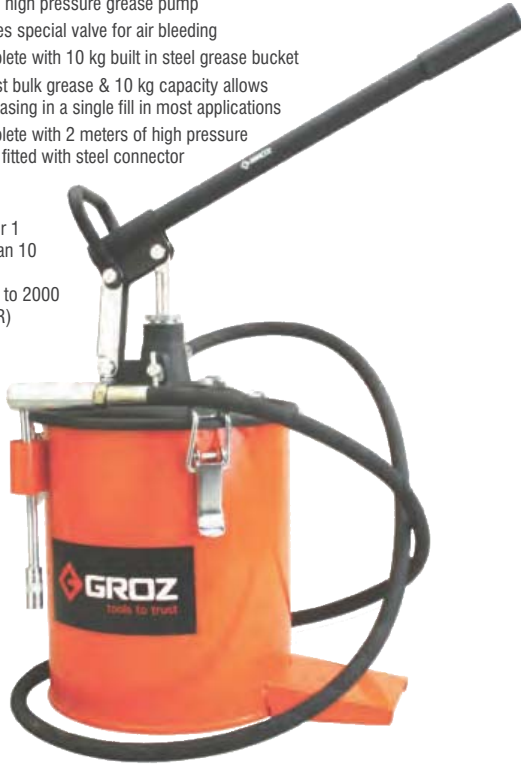

Code	Delivery
GRO2183	9gms / Stroke

GROZ **GREASE FOOT PUMP - MINI LUBE**
tools to trust

- Pump is operated by foot press of the spring loaded system
- The hose gets charged with grease, which can then be dispensed through the Super Gun fitted at the end of the hose
- A single charge provides 30 shots of grease
- High pressure / high volume feature is very useful to open blocked grease fittings
- 1,5m hose



Switch for high pressure / high volume setting



Super Gun with 360° swivel

Code	Delivery
GRO2135	1.25g / Stroke

GROZ **HIGH PRESSURE GREASE PUMP**
tools to trust

- An easy-to-use, portable, high pressure, hand operated grease pump
- Provides volume greasing where power is not available or when an air operated grease pump cannot be afforded and high pressure greasing is required
- Ideal for clean greasing of machinery, equipment, trucks and cars
- Pump has a steel construction with a cast aluminium head and solid steel pumping chamber
- Supplied complete with 310 mm drum cover 255 - 282 mm rubber lining follower plate 25.4 mm inner diameter x 1220 mm high pressure flexible hose fitted with a professional 4 jaw coupler
- Depth adjustable



Code	Grease Pail Size
GRO2172	20kg

GROZ **AIR OPERATED GREASE RATIO PUMP**
tools to trust

- A compact and practically noiseless air operated 50 : 1 ratio pump
- Ideal for applications where there is a continuous need for high pressure grease
- Can be used without an airline lubricator as the motor is non-corroding
- Use with light and self collapsing grease up to NLGI #2
- Delivery: 1.1kg NLGI #2 grease per minute
- Supplied complete with drum cover rubber lined follower plate 213 cm high pressure hose, Z swivel and grease control gun
- Air consumption: 9 cfm per minute
- Required air pressure: 6 - 8 Bar
- Spare pump kits are available, quote part number GRO2176
- Spare motor kits are available, quote part number GRO2178



Code	Grease Pail Size
GRO2175	20kg
GRO2180	50kg

Spare Hose for GRO2175/2180	
Code	Length
GRO2143	213cm

Automotive

GROZ EZEE FLO PUMP
tools to trust



- Versatile hand lift pump for use on 20 litre drums
- Heavy duty suction tube with 19 mm extension and high density polyethylene head
- Interchangeable bung adaptors fit drum with Rieke spout and regular opening
- Supplied complete with 1,2 m hose and curved metal spout
- Use for engine and gear oil, antifreeze and light fuels
- NOT suitable for water based liquids and corrosive materials

Code	Delivery
GRO3285	1 Litre / 15 Strokes

GROZ ROTARY BARREL PUMP (OIL)
tools to trust



- Heavy duty transfer pump
- Pump in either direction with a few reverse turns of the handle
- Sturdy cast iron construction with hi-nitrile rubber seals
- Supplied with suction tube, bung nut and steel discharge spout threaded 3/4" NPT
- Fits 50 - 205 litre barrels
- Telescopic feed shaft
- For diesel and non-corrosive petroleum based fluids
- NOT suitable for water based liquids and corrosive materials

Code	Delivery
GRO3290	5 Litre / 20 Turns

GROZ GEARED ROTARY BARREL FUEL PUMP - HEAVY DUTY
tools to trust



- Geared rotary barrel pump with 3 times discharge per rotation
- For every complete handle turn the rotor turns 3 times
- Dispenses 55 gallons/ 205 litres in 3 minutes
- Discharge through 1.8 metre of delivery hose with metal nozzle
- Aluminium die cast handle with security locking latch
- 50mm cast iron bung adaptor
- Built in nozzle holder
- Pump inlet fitted with easy to clean wire mesh screen
- Complete with 3 piece threaded suction tube for use on 50 and 205 litre barrels
- Suitable for fuel and aviation fuel
- NOT for use with corrosive liquids, solvents, alkalis etc.

Code	Delivery
GRO2160	205 Litres / 3 Mins

GROZ ROTARY CHEMICAL PUMP
tools to trust



- Engineered for use with media which a regular cast iron pump cannot be used
- Suitable for use with water based media, antifreeze, gasoline, acids, chemicals etc in addition for use with all petroleum based products
- Pump body, outlet and suction tube are manufactured from glass filled polypropylene
- For use on 50 - 205 litre drums
- Do not use with acetone, lacquer, mineral oils, solvents, turpentine etc.

Code	Delivery
GRO2190	5 Litre / 20 Turns

Automotive

GROZ tools to trust **LEVER PUMP - HIGH VISCOSITY**

- Polyethylene / polyacetal, other, construction
- Specifically for use with high viscosity materials
- Opening vent cap on top stops discharge
- Complete with tube and flexible discharge hose
- Use with lightweight non-inflammable liquids only
- Water based liquids, detergents ,anti-freeze, hydraulic oils etc
- **DO NOT** use for fuel or thinners transfer
- **DO NOT** use with hot liquids above 60°C



Code	Delivery
GRO3297	500ml / Stroke

GROZ tools to trust **VERTICAL CHEMICAL PUMP**

- For use on 50 - 205 litre drums
- Body is constructed from nylon with stainless steel shaft and teflon seals
- Excellent for use with paint thinners
- Also used for pumping acetone, antifreeze, brake klean, detergents, glycerine, water, weed killer and mild acids
- Do not use with strong acids, bleach, gasoline, etc.

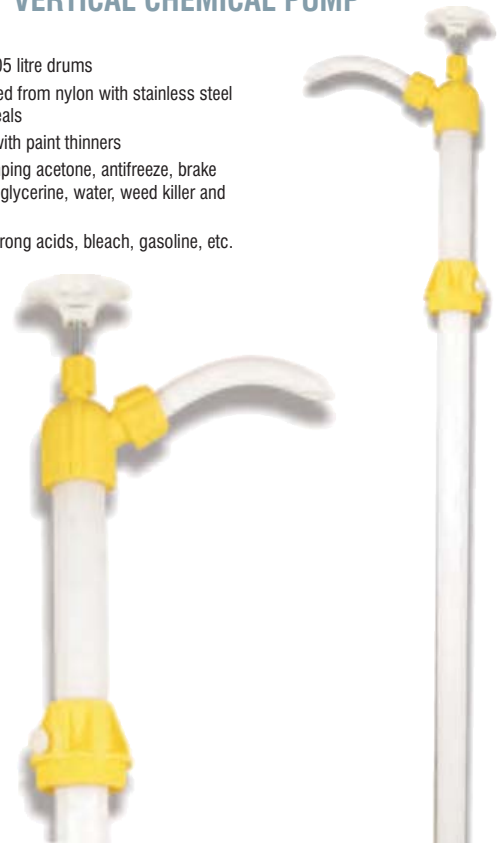

Code	Delivery
GRO2195	400ml / Stroke

GROZ tools to trust **SIPHON PUMP**

- Polyethylene siphon pump
- Pumps liquids to lower levels than pump
- Primes and pumps within 6-7 strokes
- Requires no further actions to keep working
- Opening vent cap on top stops discharge
- To pump to higher levels, continuous pumping is needed
- Complete with flexible corrugated discharge tube
- Use with lightweight non-inflammable liquids only
- **DO NOT** use with hot liquids above 60°C



Code	Delivery
GRO3295	6.5 LPM

GROZ tools to trust **SIPHON PUMP**

- Polyethylene siphon pump
- Pumps liquids to lower levels than pump
- Primes and pumps within 6-7 strokes
- Requires no further actions to keep working
- Opening vent cap on top stops discharge
- To pump to higher levels, continuous pumping is needed
- Complete with flexible corrugated discharge tube
- Use with lightweight non-inflammable liquids only
- **DO NOT** use with hot liquids above 60°C



Code	Delivery
GRO3296	17.5LPM

GROZ DRUM PLUG SPANNER

- Non-sparking aluminium drum wrench
- Convenient and compact design for easy storage
- Manufactured from cast aluminium (LM25)
- Ends of the wrench have a special construction which fit perfectly onto most 50 and 19 mm drum plugs
- Wrench is hardened and tempered for increased strength



Code	Size
GR05530	19mm & 50mm

GROZ BILGE PUMP KIT

- Hand operated diaphragm pump, designed to work in any position - vertical, horizontal, at an angle or even upside down
- Pump can be mounted anywhere; on a wall, wooden base, drum etc.
- Pump handle can be fitted in any position, making installation very easy



Code	Delivery
GR03292	16.6 LPM



- Constructed from minimal parts, the pump is virtually maintenance free
- High chemical compatibility making it useful for a variety of applications in industrial, agricultural, automotive and marine
- **DO NOT** use with food grade media or any material not compatible with the pump's components

GROZ OIL CAN

- Rigid and flexible spout included
- Easy-to-use pistol grip oil can has a deluxe brass suction pump
- All brass pump mechanism



Code	Size
GR02790	180ml

GROZ OIL CANS

- The PT series of oil cans has a modern and contemporary design with a dome shaped body
- The oil can body is seamlessly drawn from heavy gauge, tin coated sheet steel and has a premium powder coated finish
- The pump has two ball valves for large volume delivery per stroke
- The suction valve at the bottom of the pump is without a spring preventing malfunction due to resinous oil and a sticking valve
- All brass pump mechanism
- Oil cans come complete with rigid and flexible spouts



Code	Size
GR02800	300ml
GR02820	500ml
GR02840	700ml

GROZ HIGH FLOW FUEL FILTER

- Complete with 10 micron fuel filter element
- Durable & lightweight design for easy installation on both mobile & stationary fuel tanks and on gasoline & diesel fuel pumps
- Ideal for use in agricultural & industrial applications
- Rust & weather resistant for years of service
- The 10 micron paper filter element filters even small particles of rust, scale, grit, dirt, sand & lint at a gravity flow of 19 litres / minute with only a 24" (600 mm) head
- The filter element has 366 square inches of filtering surface which results in more particle retention, which means cleaner fuel, and fewer costly engine repairs
- Replacement filter elements available as spare
- Also available water block fuel filter element which separates water from fuel



WETTED COMPONENTS
Aluminium, Polypropylene, NBR, Steel, Paper element, Nylon, Brass

RECOMMENDED USE
Petrol, diesel fuel.

DO NOT USE
With Water based products, gasohol, aviation fuels, race fuels etc

Code	Size
GR02161	1" BSP

GROZ REPLACEMENT FILTER ELEMENTS

- Replacement filter elements available as spare

WETTED COMPONENTS
Aluminium, Polypropylene, NBR, Steel, Paper element, Nylon, Brass

RECOMMENDED USE
Petrol, diesel fuel.

DO NOT USE
With Water based products, gasohol, aviation fuels, race fuels etc



Code	Size/Type
GR02162	Water Block
GR02163	Fuel Filter

Automotive

GROZ HEAVY DUTY COUPLER

- Heavy duty hydraulic coupler
- Hardened body withstands high pressures without deformation
- Hexagonal nut allows for easy tightening
- Heavy duty, 4 jaws, 10'000 PSI / 690 Bar
- 1/8" BSPT



Code	Threads
GR02210	1/8" BSPT

GROZ PROFESSIONAL COUPLER

- Professional heavy duty hydraulic coupler
- Hardened body with double wall thickness withstands very high pressures without deformation
- Hexagonal nut allows for easy tightening
- Professional. 3 jaws, 6'000 PSI / 413 Bar
- 1/8" BSPT



Code	Threads
GR02205	1/8" BSPT

GROZ STANDARD COUPLER

- Standard duty hydraulic coupler
- Sleek design allows for use on fittings with limited access
- Milled slot for easy tightening
- Standard, 4 jaws, 3'000 PSI / 207 Bar



Code	Threads
GR02212	1/8" BSPT

GROZ 360° SWIVEL COUPLER

- Z X 360° swivel fits between gun and hose for easy handling
- 6'000 PSI / 413 Bar
- Heavy duty steel construction with ball bearings for smooth operation and free movement
- Use with grease control valve GR02185



Code	Threads
GR02214	1/8" M x 1/4" F

GROZ FIXED HOOK-ON COUPLER

- Zinc die cast body for greasing 5/8" (16mm) button head fittings
- Coupler conveniently slides over the face of the button



Code	Threads
GR02207	1/8" BSPT

GROZ HEAVY DUTY SWIVELLING COUPLER

- Zinc die cast body for greasing 5/8" (16mm) button head fittings
- Coupler conveniently slides over the face of the button



Code	Threads
GR02213	1/8" BSPT

GROZ GREASE NIPPLES

- ISO TS16949 approved manufacturing
- A comprehensive range of grease nipples in BSP, SAE and mm sizes
- All sizes are available in straight, button head, 45° and 90° variants
- Packed 25 per box
- Heat treated to SAE J534 specs. Hardness on greasing end in a minimum of 83 on Rockwell 15N scale



Code	Size / Style
GR07018	1/4 BSP Straight B x 25
GR07020	1/4 SAE Straight B x 25
GR07048	1/8 BSP 90° B x 25
GR07050	1/8 BSP B/Head B x 25
GR07052	1/8 BSP Straight B x 25
GR07060	1/8 SAE Straight B x 25
GR07070	1/8 SAE 45° B x 25
GR07080	1/8 SAE 90° B x 25
GR07100	6 x 1mm Straight B x 25
GR07110	6 x 1mm 45° B x 25
GR07115	6 x 1mm 90° B x 25
GR07140	8 x 1mm Straight B x 25
GR07150	8 x 1mm 45° B x 25
GR07160	8 x 1mm 90° B x 25
GR07180	10 x 1mm Straight B x 25
GR07190	10 x 1mm 45° B x 25
GR07200	10 x 1mm 90° B x 25



GR07190
10 x 1mm 45° B x 25



GR07200
10 x 1mm 90° B x 25



GR07018
1/4 BSP Straight B x 25



GR07020
1/4 SAE Straight B x 25



GR07048
1/8 BSP 90° B x 25



GR07050
1/8 BSP B/Head B x 25



GR07052
1/8 BSP Straight B x 25



GR07060
1/8 SAE Straight B x 25



GR07070
1/8 SAE 45° B x 25



GR07080
1/8 SAE 90° B x 25



GR07100
6 x 1mm Straight B x 25



GR07110
6 x 1mm 45° B x 25



GR07115
6 x 1mm 90° B x 25



GR07140
8 x 1mm Straight B x 25



GR07150
8 x 1mm 45° B x 25



GR07160
8 x 1mm 90° B x 25



GR07180
10 x 1mm Straight B x 25



GR07190
10 x 1mm 45° B x 25



GR07200
10 x 1mm 90° B x 25



GR07180
10 x 1mm Straight B x 25

GROZ **GREASE NIPPLE ASSORTMENT**
tools to trust
- mm & SAE SIZES - 110 PIECE

- A comprehensive range of grease nipples in mm and SAE sizes
- Selection of straight, button head, 45° and 90° variants



Code	Size / Type
GRO7300	110 pce / mm
GRO7310	110 pce / SAE



OIL MEASURES

- 4 assorted sizes
- sturdily fabricated from tin plate
- Hot dip galvanized



Code	Size
BOR0005	500ml
BOR0010	1 L
BOR0015	2 L
BOR0020	5 L



FUNNEL - STRAIGHT SQUARE

- Heavy Duty
- Galvanized iron
- Fitted with sieve
- Large capacity
- Long spout



Code	Size
BOR0025	250 x 250mm



FUNNEL OFFSET - ROUND

- Heavy Duty
- Re-inforced rim
- Fitted with sieve
- Spout offset for easier access
- Large capacity

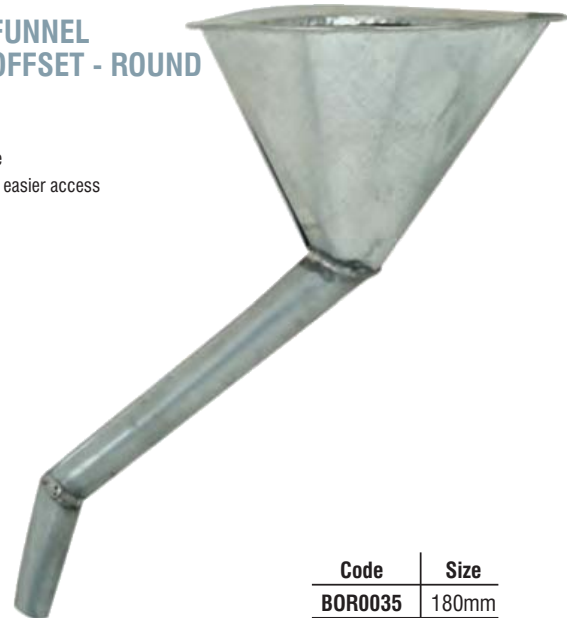

Code	Size
BOR0035	180mm



FUNNEL - STRAIGHT ROUND

- Heavy Duty
- Re-inforced rim
- Fitted with sieve
- Straight spout
- Large capacity



Code	Size
BOR0028	100mm
BOR0030	180mm



PLASTIC FUNNELS

- A convenient 4-piece funnel set for everyday use



Code	Size
HON0910	4 pce



GEAR PULLERS - HEAVY DUTY - 2 JAW

- Most popular models
- Professional quality tools manufactured to withstand heavy use in industrial applications, farms, machine shops and automotive applications
- Made from drop forged carbon alloy steel, heat treated to exacting standards with rolled threads for greater strength and durability
- The pullers have smooth surfaces and are chrome plated

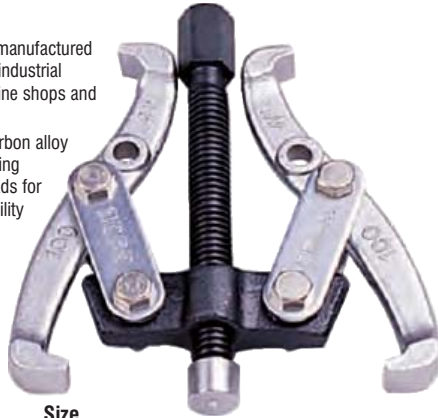

Code	Size	Ref.
RIC2680	75mm	RT14/206-3
RIC2682	100mm	RT14/206-4
RIC2684	150mm	RT14/206-6
RIC2686	200mm	RT14/206-8



MECHANICAL PULLER - TWIN LEG

- Two legs for removing gears, races, bearings and sprockets
- Double ended legs for external use
- Automotive and industrial applications
- Drop forged steel legs, beam and jaws
- Heat treated for strength and durability
- Can be upgraded for triple leg pulling



Code	Size	Ref.
SYK083000	Reach: 80mm Spread: 0-150mm	083000
SYK083100	Reach: 140mm Spread: 0-200mm	083100
SYK083200	Reach: 250mm Spread: 0-300mm	083200
SYK086000	Reach: 75mm Spread: 0-75mm	086000
SYK086200	Reach: 225mm Spread: 0-225mm	086200



GEAR PULLERS HEAVY DUTY - 3 JAW

- Most popular models
- Professional quality tools manufactured to withstand heavy use in industrial applications, farms, machine shops and automotive applications
- Made from drop forged carbon alloy steel, heat treated to exacting standards with rolled threads for greater strength and durability
- The pullers have smooth surfaces and are chrome plated



Code	Size	Ref.
RIC2688	75mm	RT14/207-3
RIC2690	100mm	RT14/207-4
RIC2692	150mm	RT14/207-6



MECHANICAL PULLER - TRIP LEG

- Three legs for removing gears, races, bearings and sprockets
- Double ended reversible legs
- Automotive and industrial applications
- Double ended legs for external use
- Drop forged steel legs, beam and jaws
- Heat treated for strength and durability



Code	Size	Ref.
SYK082700	Reach: 80mm Spread: 0-150mm	082700
SYK082800	Reach: 140mm Spread: 0-200mm	082800
SYK082900	Reach: 250mm Spread: 0-300mm	082900



MECHANICAL PULLER - TRIP LEG 083400

- Three legs for removing gears, races, bearings and sprockets
- 3 positions, adjustable legs for increased pulling options
- Automotive and industrial applications
- Double ended legs for external use
- Drop forged steel legs, beam and jaws
- Heat treated for strength and durability



Code	Size
SYK083400	Reach : 380mm Spread : 0-350mm



MECHANICAL PULLER - TWIN/TRIPLE REVERSIBLE LEG - 082805

- Twin and triple beams and double ended legs for a wide range of pulling options
- Double ended reversible leg



Code	Size	No. of Puller Combinations
SYK082805	Reach : 80mm Spread : 0-150mm	4

CONCENTRIC PULLER

- The screw operated concentric action and self adjusting legs make it easy to use
- Self-locking, self positioning legs and force screw
- Can be used in a two or three leg format
- Self positioning and self centering action prevents damage to gears or bearing shafts
- Longer service life due to concentric action
- Self-locking legs eliminate the danger of the puller legs slipping off under load
- Prolonged service life with quality forged and durable parts
- Ease of use saves operating time
- One puller for two or three leg operations



Code	Spread	Reach	Capacity	Shaft Ø	Ref.
SYK100130	35-270mm	160mm	5 Tons	3/4" x 10T	100130
SYK100150	60-380mm	250mm	10 Tons	7/8" x 14T	100150

PULLER - SELF GRIP ADJUSTABLE

- Excellent all around medium duty mechanical pullers
- Self gripping, self centering and spring load action
- High quality manufacture using the best high strength alloy steels, chrome finish on legs
- Easily adjustable for either 2 leg or 3 leg format
- Light duty, compact, quick and simple to use
- Slim design legs for good access
- Spring assisted action to ease the fitting of the puller to the work object



Code	Spread	Reach	Capacity	Ref.
SYK100320	20-150mm	150mm	1.1 Tons	100320
SYK100330	20-200mm	200mm	1.7 Tons	100330

HYDRAULIC PULLER AND SEPARATOR KIT - THIN JAWS - 193103

- Combination pack consisting of a medium duty hydraulic thin jaw puller and bearing separator
- Supplied in carton



Code	Size
SYK193103	Ext Reach : 876mm Ext Spread : 50-105mm

PULLER - HUB MECHANICAL 3 LEG 082503

- Free moving legs mounted on a floating plunger enables quick and easy attachment to vehicle hubs
- Heavy duty hammer type handle allows the application of shock force for rapid removal of sticking hubs
- Fine pitch force screw for smooth application of pulling power
- Plunger, legs and handle drop forged from high quality steel, heat treated for strength and durability
- Cars and Light Commercial Vehicles



Code SYK082503		Spread	Stud	Thread	Ø	Drive
Description	Length	Capacity	Hole Ø			Nut
Leg	158mm	203mm	15.8mm	1 1/2" x 16BSW	100mm	1 3/16"
Force Screw	285mm			1 1/2" x 16BSW		
Shock Handle	203mm					
Plunger Body						

PULLER - HYDRAULIC TWIN/TRIPLE LEG KIT - 186504

- Makes 5 different hydraulic and 1 mechanical thin jaw puller
- Thin jaw leg
- Supplied in metal case



Code	Spread	Reach	Ram Ext.
SYK186504	50-225mm	225mm	50-150mm

HYDRAULIC PULLER & SEPARATOR KIT 155200

- Makes 4 different twin/triple leg pullers, plus bearing separator kit
- Supplied in lockable metal case



Code	Spread	Reach	Ext. Spread	Ext. Reach
SYK155200	50-50mm	150mm	20-105mm	876mm

PULLER KIT - MULTI PACK

- Separator has very thin tapered edge for insertion behind close fitting bearings, gears etc
- Twin / triple leg puller has thin jaws
- Makes 5 different puller / separator combinations
- Drop forged, high quality steel, heat treated
- Supplied in carton



Code	Max Spread	Max Reach	Max Ext. Spread
SYK094003	140mm	89mm	155mm

PULLER - HYDRAULIC 3 LEG - 153900

- Removes gears, bearings, pulleys and sprockets
- Wide range of automotive and industrial applications
- Powered by 1500 series hydraulic ram (part no. 150000)
- Safe and easy to use
- 8 tons of force with minimum effort
- Easy to adjust
- Non-twisting for improved stability
- Supplied with nose piece for use on centered shafts
- Standard triple leg Puller
- Self centering, self locking
- Redesigned legs, improving strength



Code	Spread	Reach	Ram Ext.
SYK153900	130-250mm	250mm	150mm

- Grease filled
- Direct force improves stability under load
- Provides maximum withdrawal force of 80kN



Code
SYK150000

- For rapid removal of small bearings
- Covers a wide range of automotive and engineering applications
- Including alternators/generators, domestic appliances, power tools and pumps
- Self-centring force screw with 'T' bar and 13mm hexagon drive
- Drop forged legs with independent leaf springs
- Securing collar tightens under load for positive, non slip pulling action
- Suitable for ISO referenced bearings
- 1 ton capacity



Code	Reach	Spread
SYK082150	19-73mm	19-45mm

BEARING REMOVER - BLIND HOUSING MULTIPULL® - 098200

- These special pullers will remove blind housing bearings without the need to dismantle machinery or remove the running shaft
- Positive seating allows even tension on inner and outer bearing rings, reducing resistance
- Stabilisers reduce sideways movement and self-centre the puller
- Supplied in blow mould case



Code	Min. Spread	Max. Spread	Adaptor Ø	Reach
SYK098200	56mm	210mm	16-31.75mm	490mm

BEARING SEPARATOR

- Individual separators for removing and refitting bearings
- Can be used with any of the Sykes-Pickavant design of pullers, where standard legs cannot gain access
- Tapered edges provide all around support
- Use with 0830001, 083100, 083200, 083300, 094000, 094100, 094200, 094300



Code	External Spread	Ref.
SYK095000	10-55mm	095000
SYK095100	20-105mm	095100
SYK095200	35-140mm	095200
SYK095300	50-175mm	095300

COIL SPRING COMPRESSOR - SCREW TYPE - 083805

- Set of 3 threaded screws and hook-type jaws
- For additional safety when working on modern high-tension springs
- For added safety, Sykes-Pickavant recommends the use of this type of spring compressor in sets of three on all occasions



Code

SYK083805

VALVE SPRING LIFTER - 11066/1

- Bright nickel-plated
- 2 piece jaw



Code

STW74122001

Clamp Width

75-225mm

VALVE SPRING COMPRESSOR - 660210

- Removes valves in small/medium petrol and diesel engines
- Cam action provides parallel lift
- Automatic locking action
- Simple to operate T bar and screw adjuster
- With straight, adjustable width jaws



Code

SYK660210

Jaw Opening

70-135mm

Throat Depth

150mm

VALVE SPRING COMPRESSOR - OHC 660430

- Removes valves in OHC petrol and diesel engines
- Also fits a wide variety of small and medium size OHV engines
- Cam action tool provides parallel lift
- Automatic locking action
- Simple to operate T bar and screw adjuster
- Open, 'bucket' style jaw gives excellent visibility aiding access to difficult areas
- Suits over cam engines



Code

SYK660430

Jaw Opening

63-129mm

Throat Depth

158mm



PISTON RING COMPRESSOR

- Double broached design for use on all passenger cars
- Two band ratchet type with enlarged crimped edge to prevent compressor from entering the cylinder
- Double tension band eliminates bottom flare
- Made from high grade spring steel
- Allen key included



Code	Size	Ref.
RIC0930	53x125x75mm	RT14/110B
RIC0935	60x175x100mm	RT14/111B
RIC0937	60x175x150mm	RT14/112B



PISTON RING COMPRESSOR

- Made of spring steel
- Stepless adjustment with hexagon key wrench



Code	Ref
STW74140000	11068/0
STW74140001	11068/1
STW74140003	11068/2



PISTON RING COMPRESSOR - 660370

- For cars and light commercial vehicles
- Complete with square drive key
- With spring assisted ratchet type lock



Code	Capacity Ø	Depth
SYK660370	57-125mm	80mm



PISTON RING COMPRESSOR - 032200

- For large commercial vehicles, industrial and agricultural engines



Code	Size	Length
SYK032200	90-175mm	165mm



HYDRAULIC BOTTLE JACKS

- For easy lifting, bending and pushing on a wide variety of automotive, truck, industrial and construction jobs
- Cars, light trucks, vans, medium trucks, recreational vehicles, motor homes, caravans, boat trailers, farm equipment, off-road equipment
- Can be used horizontally or vertically
- Heat treated extension screw
- Automatic bypass system
- All Bottle jacks are fitted with safety overload valves and are supplied with 2 or 3 part handles
- **NOTE: when used at an angle or horizontal, pump must be in an upright position**



Part No.	Capacity (Tons)	A Min. Height (mm)	B Max. Height (mm)	C Hydraulic Lifting (mm)	D Screw Extension (mm)	Nett Weight (kg)
MOB2000	2 (2 Stage)	157	387	180	50	3.7
MOB2001	2	181	345	116	48	2.9
MOB2002	3	194	372	118	60	3.6
MOB2003	5	216	413	127	70	4.8
MOB2004	8	230	457	147	80	6.3
MOB2005	12	230	465	155	80	8.0
MOB2009	12 (Short)	152	270	78	40	6.8
MOB2011	15	230	440	150	80	8.9
MOB2006	20	242	452	150	60	11.5
MOB2010	20 (Short)	165	286	81	42	9.9
MOB2007	30	280	460	180	-	23.6
MOB2008	50	305	483	178	-	50.4
MOB2012	100	305	461	156	-	90.6

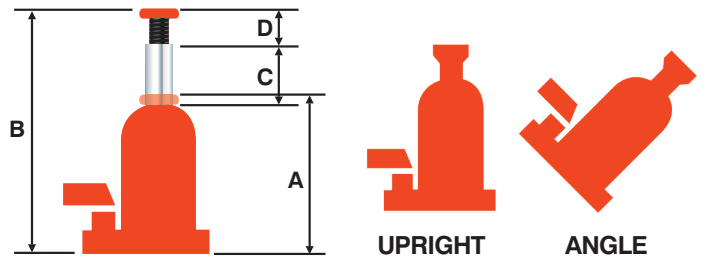

bosal SCISSOR JACK - 1 TON

- Solid construction
- Superior strength, stability and durability
- Compact and easy to stow away
- Suitable for light commercial vehicles



Code	Min Height	Max Height
BOS0560	100mm	360mm



SERVICE JACK - 3 TON - SHORT BODY

- For general purpose lifting requirements with safe and stable load handling
- Polished ram and plunger protecting seals from abrasion
- Built in safety valve ensures safe operation and prevents overloading
- Patented hydraulic bypass system prevents ram plunger from over-travelling
- Equipped with patented quick-lift foot pedal offering quick pumping to reach vehicle chassis
- Handle actuated release valve provides metered control at any desired lowering speed
- Conforms to ANSI/ASME safety standards
- All service jacks have swivel castors for easy steering

Code	Capacity (Tons)	Min Height (mm)	Max Height (mm)	Overall Length (mm)	Overall Width (mm)	Overall Height (mm)	Gross Weight (kg)
MOB3019	3	140	490	637	341	167	39.7



Automotive



MAGIC LIFT SERVICE JACK - 3 TON - SHORT BODY

- **Fast & Safe!** Extraordinary lifting speed with Magiclift U.S. Patent No. 5,755,099
- **Special Feature of MOB25056 & MOB29039 HTR and L.C.S.**
Mechanism HTR (Hold-To-Run) mechanism is designed to assure users' maximum safety when the valve is released. LCS provides user the maximum safety.
- Handle actuated release valve provides precise metered control of lowering speeds
- Wide stance and low centre of gravity provide optimum stability under load stress
- Extended long frames allow easy positioning contact of hard-to-reach lift points in the application of automotive, heavy-duty trucks, industrial & agricultural garages

ONLY 5 PUMPS
TO REACH
FULL HEIGHT!



MagicLift

Code	Jack Features/ Type	Capacity (Tons)	Min Height (mm)	Max Height (mm)	Overall Length (mm)	Overall Width (mm)	Overall Height (mm)	Gross Weight (kg)
MOB3001	Short Body	3	95	580	755	335	160	43.0



MAGIC LIFT SERVICE JACK - 2 TON - LONG BODY

- **Fast & Safe!** Extraordinary lifting speed with Magiclift U.S. Patent No. 5,755,099
- **Special Feature of MOB25056 & MOB29039 HTR and L.C.S.**
Mechanism HTR (Hold-To-Run) mechanism is designed to assure users' maximum safety when the valve is released. LCS provides user the maximum safety.
- Handle actuated release valve provides precise metered control of lowering speeds
- Wide stance and low centre of gravity provide optimum stability under load stress
- Extended long frames allow easy positioning contact of hard-to-reach lift points in the application of automotive, heavy-duty trucks, industrial & agricultural garages

ONLY 5 PUMPS
TO REACH
FULL HEIGHT!



MagicLift

Code	Jack Features/ Type	Capacity (Tons)	Min Height (mm)	Max Height (mm)	Overall Length (mm)	Overall Width (mm)	Overall Height (mm)	Gross Weight (kg)
MOB25023	Long Body	2	100	815	1044	392	204	74.5



MAGIC LIFT SERVICE JACK - 3 TON - LONG BODY

- **Fast & Safe!** Extraordinary lifting speed with Magiclift U.S. Patent No. 5,755,099
- **Special Feature of MOB25056 & MOB29039 HTR and L.C.S.**
Mechanism HTR (Hold-To-Run) mechanism is designed to assure users' maximum safety when the valve is released. LCS provides user the maximum safety.
- Handle actuated release valve provides precise metered control of lowering speeds
- Wide stance and low centre of gravity provide optimum stability under load stress
- Extended long frames allow easy positioning contact of hard-to-reach lift points in the application of automotive, heavy-duty trucks, industrial & agricultural garages

ONLY 5 PUMPS
TO REACH
FULL HEIGHT!



MagicLift

Code	Jack Features/ Type	Capacity (Tons)	Min Height (mm)	Max Height (mm)	Overall Length (mm)	Overall Width (mm)	Overall Height (mm)	Gross Weight (kg)
MOB29039	Long Body	3	95	508	997	380	173	53.1



MAGIC LIFT SERVICE JACK - 5 TON - LONG BODY

- **Fast & Safe!** Extraordinary lifting speed with Magiclift U.S. Patent No. 5,755,099
- **Special Feature of MOB25056 & MOB29039 HTR and L.C.S.**
Mechanism HTR (Hold-To-Run) mechanism is designed to assure users' maximum safety when the valve is released. LCS provides user the maximum safety.
- Handle actuated release valve provides precise metered control of lowering speeds
- Wide stance and low centre of gravity provide optimum stability under load stress
- Extended long frames allow easy positioning contact of hard-to-reach lift points in the application of automotive, heavy-duty trucks, industrial & agricultural garages

ONLY 5 PUMPS
TO REACH
FULL HEIGHT!



MagicLift

Code	Jack Features/ Type	Capacity (Tons)	Min Height (mm)	Max Height (mm)	Overall Length (mm)	Overall Width (mm)	Overall Height (mm)	Gross Weight (kg)
MOB25056	Long Body	5	165	565	1338	428	280	91.5



TROLLEY RACING JACK - 1.5 TON

- Extra low profile design, professional racing jack ideal for racing fanatics
- Manufactured from high grade aluminium with an anodized finish
- Two piece handle for compact storage

Code	Jack Features/ Type	Capacity (Tons)	Min Height (mm)	Max Height (mm)	Hydraulic Lifting (mm)	Overall Length (mm)	Overall Width (mm)	Overall Height (mm)	Gross Weight (kg)
MOB3000	Short Body	1	90	450	360	680	305	155	19.5

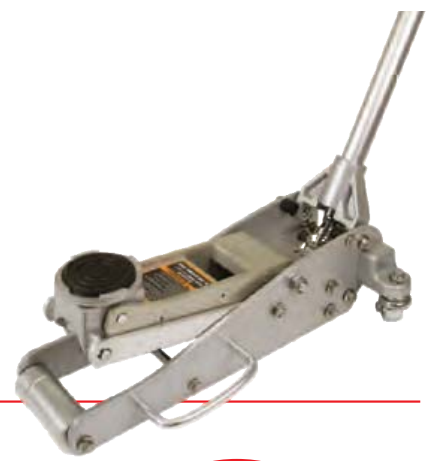

SERVICE JACK - 5 TON LONG BODY

- Wide stance and low centre of gravity provide optimum stability under load stress
- Polished ram and plunger protecting seals from abrasion
- Built in safety valve ensure safe operation and prevents overloading
- Patented hydraulic bypass system prevents ram plunger from over-travelling
- Equipped with patented quick-lift foot pedal offering quick pumping to reach vehicle chassis
- Handle actuated release valve provides metered control at any desired lowering speed

Code	Jack Features/ Type	Capacity (Tons)	Min Height (mm)	Max Height (mm)	Overall Length (mm)	Overall Width (mm)	Overall Height (mm)	Gross Weight (kg)
MOB3003	LongBody	5	178	686	1468	430	195	106.0



TROLLEY JACK - 12 TON

- Metered release system allows for precise load control at any desired lowering speed
- Large saddle
- Extra wide wheels and solid stance designed for stability under load stress
- Convenient foot pedal for fast, no load lifts
- All service jacks have swivel castors for easy steering

Code	Capacity (Tons)	Min Height (mm)	Max Height (mm)	Overall Length (mm)	Overall Width (mm)	Hydraulic Lift (mm)	Gross Weight (kg)
MOB3004	12	180	600	1740	330	420	120.0



TROLLEY JACK - 20 TON

- Metered release system allows for precise load control at any desired lowering speed
- Large saddle
- Extra wide wheels and solid stance designed for stability under load stress
- Convenient foot pedal for fast, no load lifts
- All service jacks have swivel castors for easy steering

Code	Capacity (Tons)	Min Height (mm)	Max Height (mm)	Overall Length (mm)	Overall Width (mm)	Hydraulic Lift (mm)	Gross Weight (kg)
MOB3006	20	180	600	1910	340	420	165.0



FLOOR STYLE TRANSMISSION JACK - 1 TON

- The adjustable head can be tilted forward, backward and side to side for optimum alignment of transmission bolt patterns and pins
- Hydraulic system is protected from internal damage by a patented bypass mechanism
- Load restraining chain is provided for raising and lowering safety
- Four heavy duty steel castor wheels with swivel ball bearings allow easy movement and positioning of the jack
- 360° rotating jacking socket for maximum directional operation

Code	Capacity (Tons)	Min Height (mm)	Max Height (mm)	Hydraulic Lift (mm)	Gross Weight (kg)
MOB3011	1	210	780	565	75.0





FLOOR STYLE TRANSMISSION JACK - 1.5 TON

- The adjustable head can be tilted forward, backward and side to side for optimum alignment of transmission bolt patterns and pins
- Hydraulic system is protected from internal damage by a patented bypass mechanism
- Load restraining chain is provided for raising and lowering safety
- Four heavy duty steel castor wheels with swivel ball bearings allow easy movement and positioning of the jack
- 360° rotating jacking socket for maximum directional operation

Code	Capacity (Tons)	Min Height (mm)	Max Height (mm)	Hydraulic Lift (mm)	Gross Weight (kg)
MOB3007	1.5	200	945	745	144.0

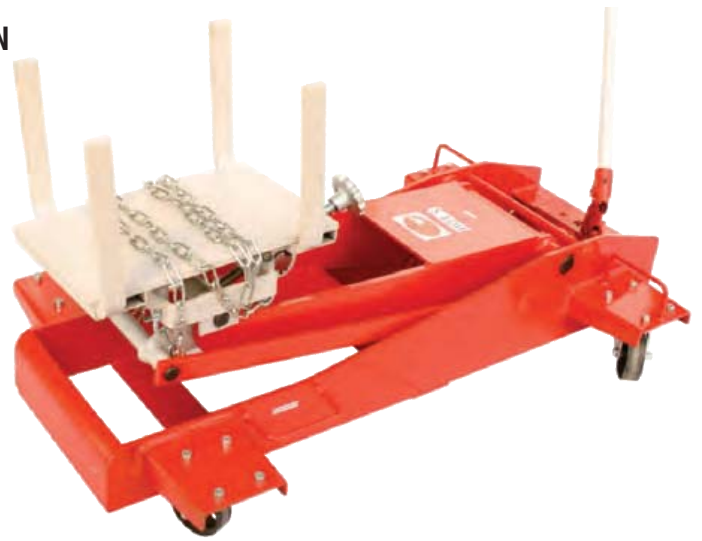

PIT STYLE TRANSMISSION JACK - 1 TON

- The adjustable head can be tilted forward, backward and side to side for optimum alignment of transmission bolt patterns and pins
- Hydraulic system is protected from internal damage by a patented bypass mechanism
- Load restraining chain is provided for raising and lowering safety
- Four heavy duty steel castor wheels with swivel ball bearings allow easy movement and positioning of the jack
- 360° rotating jacking socket for maximum directional operation
- IDEAL FOR USE UNDER 2 OR 4 POST LIFTS



Code	Capacity (Tons)	Min Height (mm)	Max Height (mm)	Hydraulic Lift (mm)	Gross Weight (kg)
MOB3009	1	1216	2046	830	46.9



HYDRAPNEUMATIC TRUCK JACK - 20 TON

- Safety valve to prevent internal damage or operator injury
- Air operated function enables quick lifting (minimum air pressure required is 8-14 bar)
- Large diameter solid rubber wheels for easy movement and positioning
- A choice of three handle angles: 90° for space saving storage, 45° for easy carrying, 0° for access to lifting point
- Carrying handle
- Self return spring to minimise operator effort
- Built-in silencer (filter) to reduce working noise
- Extension screw allows for added height adjustment
- U.S. patented built-in bypass device (Patent No.4 077 608) protects the hydraulic cylinder from over pumping
- Chrome plated rams

Code	Capacity (Tons)	Min Height (mm)	Max Height (mm)	Hydraulic Lifting (mm)	Gross Weight (kg)
MOB3012	20	260	495	135	35.4

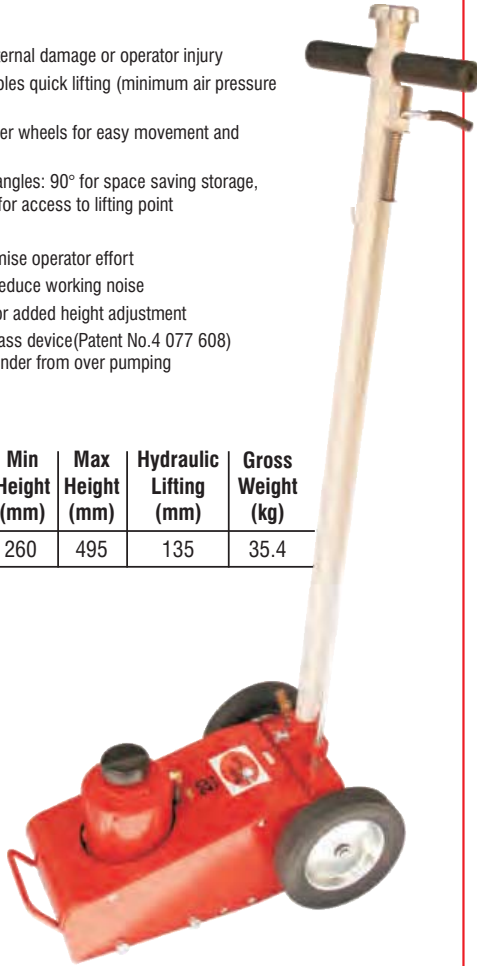

HYDRAPNEUMATIC TRUCK JACK - 30 TON

- Safety valve to prevent internal damage or operator injury
- Air operated function enables quick lifting (minimum air pressure required is 8-14 bar)
- Large diameter solid rubber wheels for easy movement and positioning
- A choice of three handle angles: 90° for space saving storage, 45° for easy carrying, 0° for access to lifting point
- Carrying handle
- Self return spring to minimise operator effort
- Built-in silencer (filter) to reduce working noise
- Extension screw allows for added height adjustment
- U.S. patented built-in bypass device (Patent No.4 077 608) protects the hydraulic cylinder from over pumping
- Chrome plated rams

Code	Capacity (Tons)	Min Height (mm)	Max Height (mm)	Hydraulic Lifting (mm)	Gross Weight (kg)
MOB3046	30	280	458	178	47.0

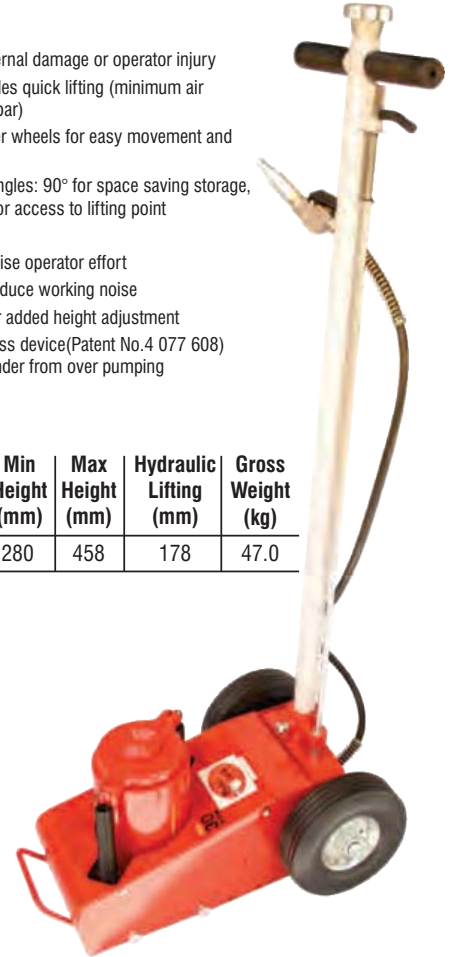

HYDRAPNEUMATIC TRUCK JACK - 50 TON

- Safety valve to prevent internal damage or operator injury
- Air operated function enables quick lifting (minimum air pressure required is 8-14 bar)
- Large diameter solid rubber wheels for easy movement and positioning
- A choice of three handle angles: 90° for space saving storage, 45° for easy carrying, 0° for access to lifting point
- Carrying handle
- Self return spring to minimise operator effort
- Built-in silencer (filter) to reduce working noise
- Extension screw allows for added height adjustment
- U.S. patented built-in bypass device (Patent No.4 077 608) protects the hydraulic cylinder from over pumping
- Chrome plated rams

Code	Capacity (Tons)	Min Height (mm)	Max Height (mm)	Hydraulic Lifting (mm)	Gross Weight (kg)
MOB3047	50	305	483	178	73.0

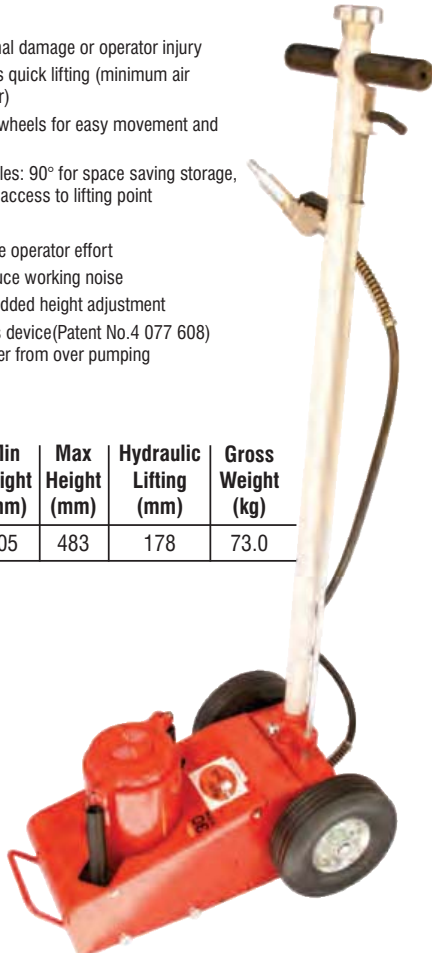

FORKLIFT JACK - 5 TON

- Scissor mechanism for maximum lift
- Compact and maneuverable

Code	Capacity (Tons)	Min Height (mm)	Max Height (mm)	Overall Length (mm)	Overall Width (mm)	Gross Weight (kg)
MOB1147	5	70	365	725	315	120.0





PALLET JACK - 2,5 TON

- Double arm mobile jack
- Used for lifting and moving pallets
- Lift height - approx. 175 mm
- Swivel wheels
- Pump handle to engage hydraulic lift
- Lowering release on main handle at fingertip

Code	Capacity (Tons)	Overall Length (mm)	Overall Width (mm)
MOB2095	2,5	1220	685



FARMER'S JEEP JACK - 3 TON

- Extremely versatile, this jack gives the user supreme command of demanding situations that require efficient lifting, pushing, winching, hoisting and clamping



Code	Capacity (Tons)	Minimum Lift (mm)	Maximum Lift (mm)
MOB1600	3	155	1350



TRESTLE - PIN TYPE 3 TON

- Sturdy welded steel construction for superior safety and strength
- Suitable for a wide variety of automotive and agricultural applications
- Traditional pin type adjustment
- Large footprint for maximum stability
- Safety chain to prevent pin loss
- **TO BE USED IN PAIRS ONLY**

Code	Capacity (Tons)	Min Height (mm)	Max Height (mm)	Increment Height (mm)	Gross Weight (kg)
MOB2030	3	320	470	150	3.0



TRESTLE - PIN TYPE 6 TON

- Sturdy welded steel construction for superior safety and strength
- Suitable for a wide variety of automotive and agricultural applications
- Traditional pin type adjustment
- Large footprint for maximum stability
- Safety chain to prevent pin loss
- **TO BE USED IN PAIRS ONLY**

Code	Capacity (Tons)	Min Height (mm)	Max Height (mm)	Increment Height (mm)	Gross Weight (kg)
MOB2035	6	465	610	145	5.2



TRESTLE - PIN TYPE 12 TON, STANDARD

- Sturdy welded steel construction for superior safety and strength
- Suitable for a wide variety of automotive and agricultural applications
- Traditional pin type adjustment
- Large footprint for maximum stability
- Safety chain to prevent pin loss
- **TO BE USED IN PAIRS ONLY**

Code	Capacity (Tons)	Min Height (mm)	Max Height (mm)	Increment Height (mm)	Gross Weight (kg)
MOB2040	12	510	725	215	13.0



TRESTLE - PIN TYPE 12 TON, HIGH LIFT

- Ideal for truck & bus application
- Sturdy welded steel construction for superior safety and strength
- Suitable for a wide variety of automotive and agricultural applications
- Traditional pin type adjustment
- Large footprint for maximum stability
- Safety chain to prevent pin loss
- **TO BE USED IN PAIRS ONLY**

Code	Capacity (Tons)	Min Height (mm)	Max Height (mm)	Increment Height (mm)	Gross Weight (kg)
MOB2045	12	855	1065	210	21.0





TRESTLE - PIN TYPE - 20 TON

- Sturdy welded steel construction for superior safety and strength
- Suitable for a wide variety of automotive and agricultural applications
- Traditional pin type adjustment
- Large footprint for maximum stability
- Safety chain to prevent pin loss
- **TO BE USED IN PAIRS ONLY**



Code	Capacity (Tons)	Min Height (mm)	Max Height (mm)	Increment Height (mm)	Gross Weight (kg)
MOB2050	20	500	800	-	28.0



TRESTLE - RATCHET TYPE CAR/VAN - 3 TON

- Counter-weighted pawl serves as a safe, secure locking device to prevent accidental disengagement of the load
- Sturdy welded steel construction for superior safety and strength
- One piece multi-position ductile ratchet bar provides super strength and durability
- Quick adjustment mechanism securely locks into desired position
- **TO BE USED IN PAIRS ONLY**



Code	Capacity (Tons)	Min Height (mm)	Max Height (mm)	Saddle Size (mm)	Base Size LxW (mm)	Gross Weight (kg)
MOB2101	3	295	430	96x27	195x170	7.3



TRESTLE - RATCHET TYPE - 6 TON

- Counter-weighted pawl serves as a safe, secure locking device to prevent accidental disengagement of the load
- Sturdy welded steel construction for superior safety and strength
- One piece multi-position ductile ratchet bar provides super strength and durability
- Quick adjustment mechanism securely locks into desired position
- **TO BE USED IN PAIRS ONLY**



Code	Capacity (Tons)	Min Height (mm)	Max Height (mm)	Saddle Size (mm)	Base Size LxW (mm)	Gross Weight (kg)
MOB2102	6	390	618	108x32	225x276	14.5



TRESTLE - RATCHET TYPE - 12 TON

- Counter-weighted pawl serves as a safe, secure locking device to prevent accidental disengagement of the load
- Sturdy welded steel construction for superior safety and strength
- One piece multi-position ductile ratchet bar provides super strength and durability
- Quick adjustment mechanism securely locks into desired position
- **TO BE USED IN PAIRS ONLY**



Code	Capacity (Tons)	Min Height (mm)	Max Height (mm)	Saddle Size (mm)	Base Size LxW (mm)	Gross Weight (kg)
MOB2103	12	445	692	117x38	307x274	28.0



TRUCK CHOCKS

- Manufactured from heavy gauge steel
- Solid construction
- Suitable for light commercial vehicles and cars
- Essential to prevent vehicle rolling/moving during service or wheel change
- Powder coated
- Sold in pairs

Code	Length (mm)	Width (mm)	Height (mm)	Gross Weight (kg)
MOB8004	326	204	161	9.6/Pair





HAND POWER PULLER - 2000KG

- General purpose cable pullers designed to lift, lower, stretch or pull heavy loads
- One piece body frame construction
- Chrome / zinc plated and polished for corrosion resistance
- Drop forged steel hook with spring safety latch
- East-to-reach cable release works one notch at a time for maximum safety
- Heavy duty stamped steel provides added strength in the ratchet wheel, drive pawl and stop pawl
- Heavy duty metal safety shield
- Heat treated, heavy duty bottles in the handle and body for shear resistance
- Heavy polished steel ratchet arm for smooth non-binding operation
- Heavy duty galvanised aircraft cable

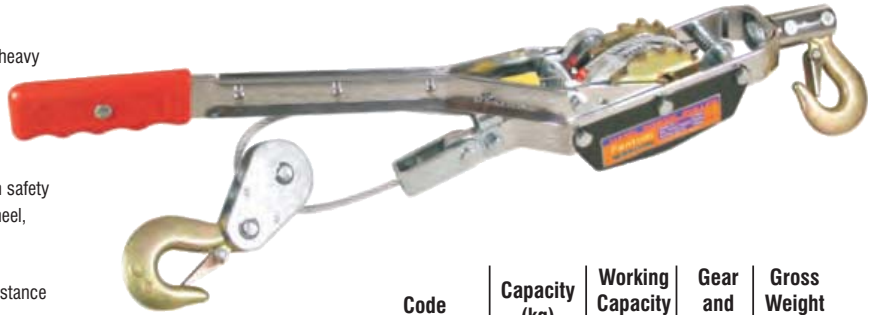

Code	Capacity (kg)	Working Capacity (kg)	Gear and Pawl	Gross Weight (kg)
MOB2119080	2000	1000	Double	24.0



HAND POWER PULLER - 4000KG

- General purpose cable pullers designed to lift, lower, stretch or pull heavy loads
- One piece body frame construction
- Chrome / zinc plated and polished for corrosion resistance
- Drop forged steel hook with spring safety latch
- East-to-reach cable release works one notch at a time for maximum safety
- Heavy duty stamped steel provides added strength in the ratchet wheel, drive pawl and stop pawl
- Heavy duty metal safety shield
- Heat treated, heavy duty bottles in the handle and body for shear resistance
- Heavy polished steel ratchet arm for smooth non-binding operation
- Heavy duty galvanised aircraft cable

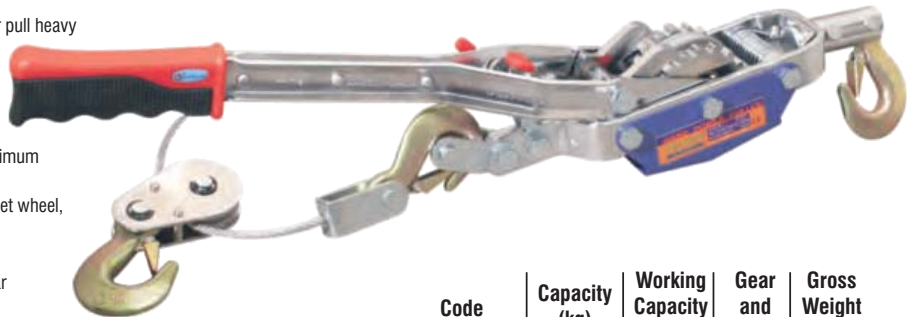

Code	Capacity (kg)	Working Capacity (kg)	Gear and Pawl	Gross Weight (kg)
MOB2119077	4000	1500	Double	30.0



HAND WINCHES

- 960kg & 1500kg capacities
- Solid gear construction
- 960kg, single gear, 2 way, 1 speed
- 1500kg, double gear, 2 way, 1 speed
- Black electrostatic discharge coating finish for improved resistance to corrosion
- Internally lubricated drum and pinion gear bushings
- Precise gear tooth engagement
- Formed reinforcement in frame for added strength
- Great for use on boat trailers and many other uses
- **CABLE NOT INCLUDED**

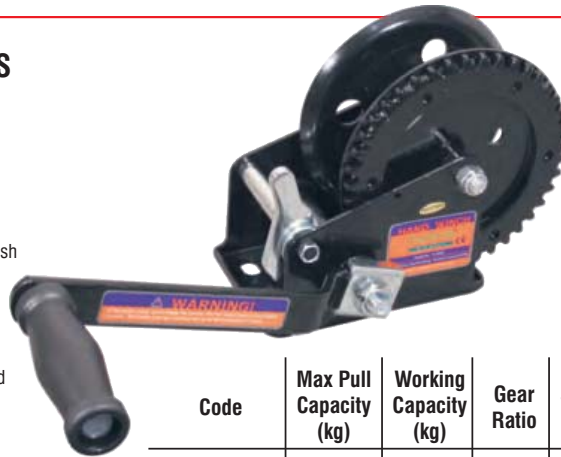

Code	Max Pull Capacity (kg)	Working Capacity (kg)	Gear Ratio	Gross Weight (kg)
MOB2119086	960	320	4:1	17.5

WINCH CABLE

- Nominal breaking load 1905kg
- Galvanised aircraft cable with one forged hook
- Cable 5mm x 10m



Code	Nominal Breaking Load (kg)	Length (m)	Gross Weight (kg)
MOB2119088	1905	10	23.0



HAND WINCHES

- 960kg & 1500kg capacities
- Solid gear construction
- 960kg, single gear, 2 way, 1 speed
- 1500kg, double gear, 2 way, 1 speed
- Black electrostatic discharge coating finish for improved resistance to corrosion
- Internally lubricated drum and pinion gear bushings
- Precise gear tooth engagement
- Formed reinforcement in frame for added strength
- Great for use on boat trailers and many other uses
- **CABLE NOT INCLUDED**

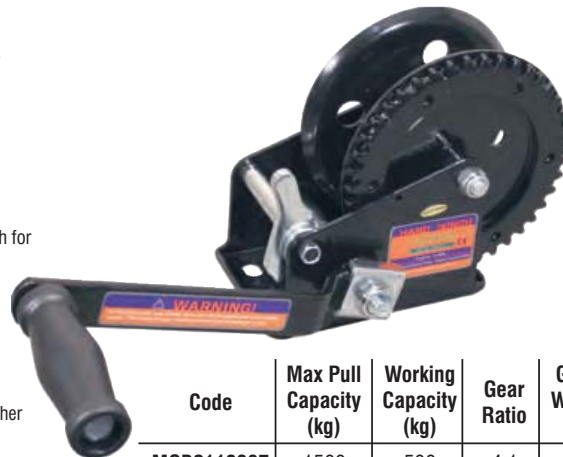

Code	Max Pull Capacity (kg)	Working Capacity (kg)	Gear Ratio	Gross Weight (kg)
MOB2119087	1500	500	4:1	20.0

WINCH CABLE

- Nominal breaking load 1905kg
- Galvanised aircraft cable with one forged hook
- Cable 5mm x 10m



Code	Nominal Breaking Load (kg)	Length (m)	Gross Weight (kg)
MOB2119088	1905	10	23.0

Mobi-Jack Hydraulic Equipment

One Year Limited Warranty for Mobi-Jack Hydraulic Equipment

For a period of ONE (1) year from the date of purchase, MOBI-JACK will repair or replace, at its option, without charge, any of its products which fails due to defect in material or workmanship, or which fails to conform to any implied warranty not excluded hereby.

1. The consumer's sole and exclusive remedy shall be the repair or replacement of defective products as described above.
2. Mobi-jack shall not be liable for loss what so ever
3. The duration of any and all expressed and implied warranties, including without limitation, any warranties of Merchantability and fitness for a particular purpose, is limited to a period of one (1) year from the date of purchase.

MAINTENANCE

- Inspect hoses and connections daily. Replace damaged components immediately with BVA Hydraulics Replacement Parts only.
- Tighten connections as needed. Use pipe thread sealing compound when servicing connections.
- Always use clean, approved hydraulic fluid and change as recommended or sooner if the fluid becomes contaminated (never exceed 400 hours). Follow pump manufacturers instructions for changing and adding hydraulic fluid. Use only good quality hydraulic fluid. We recommend Mobil DTE13M or equivalent when using with hand pump or air pump; BVA Hydraulics Oil (F01) or equivalent when using with electric pump. Never use brake fluid, transmission fluid, turbine oil, motor oil, alcohol, glycerin etc. Use of other than good quality hydraulic oil will void warranty and damage the cylinder, pump, hose etc.
- Use an approved, high-grade pipe thread sealant to seal all hydraulic connections. Teflon tape can be used if only one layer of tape is used and it is applied carefully (two threads back) to prevent the tape from being introduced into hydraulic system. A piece of tape could travel through the system and obstruct the flow of fluid and adversely affect function.

LUBRICATION & CLEANING

- Keep cylinder clean at all times.
- Any exposed threads (male or female) must be cleaned and lubricated regularly, and protected from damage.
- Lubricate with light machine oil.
- If a cylinder or ram has been exposed to rain, snow, sand, airborne abrasive, or any corrosive environment, it must be cleaned, lubricated, and protected immediately after exposure. Daily clean exposed ram with clean cloth dampened with light machine oil. Protect exposed ram from the elements at all times.
- Keep the hydraulic system as free of dirt as possible. When not in use, couplers must be sealed with dust covers. All hose connections must be free of dirt and grime. Any equipment attached to the cylinder must be kept clean.

STORAGE

- Cylinders should be stored vertically with ram plunger fully retracted in a dry, protected area, not exposed to corrosive vapor, dust or other harmful elements. When a cylinder has not been used for a period of 4 months, it should be connected to a pump and fully extended and then retracted a minimum of 5 times. This cycle will lubricate the cylinder wall, reducing the possibility of corrosion and damage thereof.

HOW TO REMOVE FAULTY COUPLER

- If cylinder does not retract,
 1. Secure load by other means.
 2. Depressurize pump and hose.
 3. Remove the cylinder from application.
 4. Disconnect and replace with new coupler.

IMPORTANT

- Do not attempt to grasp with pliers or wrench without first wrapping the jaws of such tool with rags or similar padding.
- How to bleed air from system:
 1. Place pump at a higher elevation than the hose and cylinder as shown in Figure 2.
 2. Operate pump to fully extend and retract the cylinder 2 or 3 times. The objective is to force the air bubbles up hill and back to the pump reservoir.
 3. Follow pump instruction manual to bleed the air from pump reservoir. On most pumps, air can escape by opening the oil filler plug/screw.

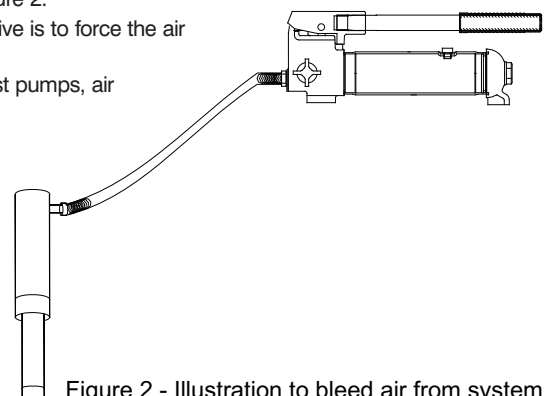

Figure 2 - Illustration to bleed air from system



SINGLE ACTING CYLINDERS

- High Tonnage Cylinders
- Heavy Duty Return Spring for quicker retraction.
- Solid steel cylinder body
- Maximum Operating Pressure 10,000 PSI

Model Number	Stroke (mm)	A Min. Height (mm)	B Max. Height (mm)	Oil Capacity (cc)	Weight (Kg)	Cylinder Capacity
MOB7000	78	69	247	50	1.6	5T=45KN
MOB7005	129	221	350	83	2.1	5T=45KN
MOB7010	102	174	276	147	3.1	10T=101KN
MOB7015	151	250	401	218	4.3	10T=101KN
MOB7020	202	301	503	291	5.4	10T=101KN
MOB7025	101	200	301	204	5.1	15T=142KN
MOB7030	152	270	422	308	7.0	15T=142KN
MOB7035	203	321	524	411	8.0	15T=142KN
MOB7040	254	372	626	515	9.3	15T=142KN



FLAT BODY CYLINDERS

- Body made of high quality solid steel.
- Extremely low design for use in narrow areas where standard cylinders will not fit.
- Maximum working pressure: 700 bar (10,000 psi).

Model Number	Stroke (mm)	A Min. Height (mm)	B Max. Height (mm)	Oil Capacity (cc)	Weight (Kg)	Cylinder Capacity
MOB7045	11	43	54	16	1.5	10T=104KN
MOB7050	11	51	62	31	2.7	20T=194KN
MOB7055	13	59	71	54	4.4	30T=287KN



LOW PROFILE CYLINDERS

- High Tonnage Cylinders
- Compact design for use in confined spaces.
- Plunger wiper reduces contamination and extends the cylinder-life.
- Special designed return spring ensures a quick retraction and extends the life of the spring.
- Industrial hard chrome plated ram helps prevents scratching and corrosion.
- Plunger end is grooved to reduce load slipping.
- Includes high flow coupler and dust cap.
- Maximum working pressure: 700 bar (10, 000 PSI)



Packed individually.

Model Number	Stroke (mm)	A Min. Height (mm)	B Max. Height (mm)	Oil Capacity (cc)	Weight (Kg)	Cylinder Capacity
MOB7060	38.0	88	126	58	2.6	10T=106KN
MOB7065	44.5	99	144	126	5.0	20T=198KN
MOB7080	62.0	117	179	259	6.8	30T=293KN

Automotive



THREADED CYLINDERS

- High quality threaded single acting cylinders
- Removable threaded plunger adapter allows for the use of a variety of threaded attachments
- Used to attach accessories to rod end and base
- Maximum working pressure: 700 bar (10,000 psi)



Cylinder Capacity 10T=101KN

Model Number	Stroke (mm)	A Min. Height (mm)	B Max. Height (mm)	Oil Capacity (cc)	Weight (Kg)
MOB7075	151	291	442	217	4.8



HYDRAULIC HAND PUMPS

- Internal pressure relief valve for overload protection
- External load release valve for single acting cylinder usage
- Large oil capacities to power a wide range of cylinders and tools
- Maximum working pressure: 700 bar (10,000 psi)



Model Number	Stage	Usable Oil Cap. c.c.	Press. Rating (bar)	Oil Disp. per Stroke (cc)	Max Oper. Force (N)	Piston Stroke (mm)	Oil Outlet Port	Weight (kg)
MOB7075	Single	600	700	2.46	486	20.0	3/8"18NPTF	5.9



AIR HYDRAULIC PUMPS

- High Strength reinforced alloy aluminum reservoir is lightweight and corrosion resistant
- Internal pressure relief valve for over load protection
- Suggested air pressure range: 114-700 psi / 8-14 bar
- Designed to be used with single acting cylinders
- Dust cover protection for the release control valve
- Dual stage release valve
- Maximum working pressure: 700 bar (10,000 psi)

Model Number	Stage	Usable Oil Cap. c.c.	Press. Rating (bar)	Air Press. Rating (bar)	Output Flow Rate (L/min)		Oil Outlet Port	Air Input Port	Weight (kg)
					No Load	Load			
MOB7095	Single	1500	700	8-14	1.07	0.18	3/8"18NPTF	1/4"18NPTF	8.2





CHAIN HOIST

- Heavy duty construction for added lifting strength and safety
- Positive ratchet assembly for secure raising and lowering
- Top and bottom hooks have safety clips
- A range of lifting weights from 0,5 - 5,0 tons available



Code	Capacity	Lift
HYC0005	0,5 Ton	2,5m
HYC0010	1,0 Ton	2,5m
HYC0015	1,5 Ton	2,5m
HYC0020	2,0 Ton	2,5m
HYC0025	3,0 Ton	3,0m
HYC0030	5,0 Ton	3,0m



LEVER HOIST

- Heavy duty construction for added lifting strength and safety
- Positive ratchet assembly for secure raising and lowering
- Top and bottom hooks have safety clips
- A range of lifting weights from 0,75 - 3,0 tons available



Code	Capacity	Lift
HYC1000	0,75 Ton	1,5m
HYC1010	1,5 Ton	1,5m
HYC1020	3,0 Ton	1,5m



ROPE HOIST - 450KG

- Pulling capacity 900kg
- Strong 22m nylon rope
- Heavy gauge metal pulleys with nylon pulley wheels
- Double grip safety hooks
- Ideal for camping, boating & general utility work



Code	Capacity	Lift
HON3035	450kg	2,5m



STANDARD FOLDING CRANE - HYDRAULIC

- Heavy duty welded construction from rugged tubular steel
- Metered control release valve enables boom lowering at a precisely controlled rate of speed
- Long hydraulic ram is equipped with a special, patented built-in bypass mechanism
- Ideal for lifting and transporting engines, transmissions, generators, pumps, compressors and other heavy equipment
- Spares available - Ram Hydraulic Unit - Caster Assembly - Front Wheels
- Crane conveniently folds away for easy storage & transportation

Crane conveniently folds away for easy storage & transportation



Boom Position	Capacity (kg)	Min Hook Height (mm)	Max Hook Height (mm)	Boom Length (mm)
1	1000	400	1970	950
2	900	300	2020	1050
3	800	200	2080	1150
4	700	100	2130	1250
5	600	-	2180	1350



Code	Capacity (Tons)	Base Length (mm)	Base Width Front (mm)	Base Width Rear (mm)	Gross Weight (kg)
MOB4001	1	1520	1120	1100	83.0



ECONOMY CRANE

- Heavy duty welded construction from rugged tubular steel
- Metered control release valve enables boom lowering at a precisely controlled rate of speed
- Long hydraulic ram is equipped with a special, patented built-in bypass mechanism
- Ideal for lifting and transporting engines, transmissions, generators, pumps, compressors and other heavy equipment
- Spares available - Ram Hydraulic Unit - Caster Assembly - Front Wheels

Boom Position	Capacity (kg)	Min Hook Height (mm)	Max Hook Height (mm)	Boom Length (mm)
1	2000	420	1524	838
2	1500	298	1790	1069
3	1000	178	2057	1295
4	500	57	2324	1524

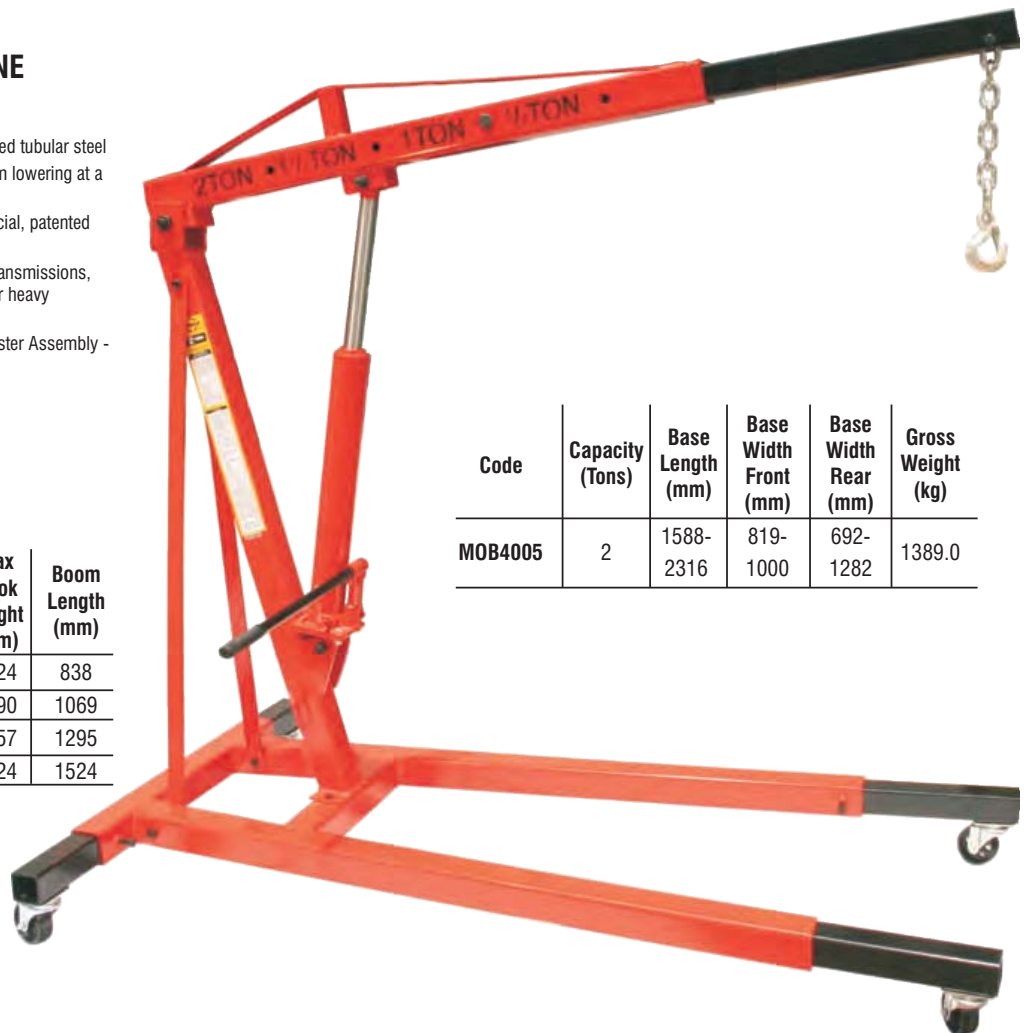

Code	Capacity (Tons)	Base Length (mm)	Base Width Front (mm)	Base Width Rear (mm)	Gross Weight (kg)
MOB4005	2	1588-2316	819-1000	692-1282	1389.0



SHOP PRESS WITH HAND PUMP - 12 TON

- Ideal for the removal or installation of gears, universal joints, pulleys, wrist pins and other press jobs
- Excellent for bending, bonding or straightening applications
- Multi-position bed for variable work height adjustment
- Heavy duty welded steel construction
- Free standing
- With hand pump



Code	Capacity (Tons)	Workbed Width (mm)	Ram Stroke (mm)	Min Work Space (mm)	Max Work Space (mm)	Gross Weight (kg)
MOB5001	12	530	154	83	883	94.5



SHOP PRESS - 20T

- Ideal for the removal or installation of gears, universal joints, pulleys, wrist pins and other press jobs
- Excellent for bending, bonding or straightening applications
- Multi-position bed for variable work height adjustment
- Heavy duty welded steel construction
- Free standing



Code	Capacity (Tons)	Workbed Width (mm)	Ram Stroke (mm)	Min Work Space (mm)	Max Work Space (mm)	Gross Weight (kg)
MOB5003	20	750	160	0	998	134



SHOP PRESS WITH HAND PUMP - 25 TON

- Ideal for the removal or installation of gears, universal joints, pulleys, wrist pins and other press jobs
- Excellent for bending, bonding or straightening applications
- Multi-position bed for variable work height adjustment
- Heavy duty welded steel construction
- Free standing
- With hand pump



Code	Capacity (Tons)	Workbed Width (mm)	Ram Stroke (mm)	Min Work Space (mm)	Max Work Space (mm)	Gross Weight (kg)
MOB5002	25	510	165	93	890	112.8



SHOP PRESS WITH HAND PUMP - 50T

- Ideal for the removal or installation of gears, universal joints, pulleys, wrist pins and other press jobs
- Excellent for bending, bonding or straightening applications
- Multi-position bed for variable work height adjustment
- Heavy duty welded steel construction
- Free standing
- With hand pump



Code	Capacity (Tons)	Workbed Width (mm)	Ram Stroke (mm)	Min Work Space (mm)	Max Work Space (mm)	Gross Weight (kg)
MOB5004	50	800	200	200	1190	385.0



BATTERY CHARGER - 6 AMP

- LED indicator for full charge
- For 12V lead acid batteries only
- Minimum capacity 20A
- Output 12V, 4A DC



Code	Input Voltage	Output Voltage
SHF0500	230Vac	12V at 4A



BATTERY CHARGER - SMART 6

- Is an automatic taper charger
- An electronic control card regulates the output voltage thereby preventing overcharging
- Potential free clamps prevents sparking when connecting to the battery
- Charger requires a minimum of 10V to be present on the battery before it will start charging
- Charger has a thermal switch embedded in the transformer which shuts the unit down if excess heat is generated
- Charger can be left connected to the battery unattended for extended periods
- The Smart Series of chargers were designed in compliance with IEC 335-2-2 and has a two year limited warranty against defects in materials and workmanship
- **RECOMMENDED FOR SEALED & VENTED BATTERIES**



Code	Input Voltage	Output Voltage
HAW6AA	230Vac	12V at 3,2A



BATTERY CHARGER - POWER 8

- Manual taper charger
- Transformer is protected by an automatic reset thermal circuit breaker
- Charger is not automatic and must be periodically monitored
- When the GREEN & ORANGE LED's come on, the battery is full and the charger must then be disconnected
- Power Series of chargers were designed in compliance with IEC 335-2-2 and has a two year limited warranty against defects in materials and workmanship
- **NOT RECOMMENDED FOR SEALED BATTERIES**

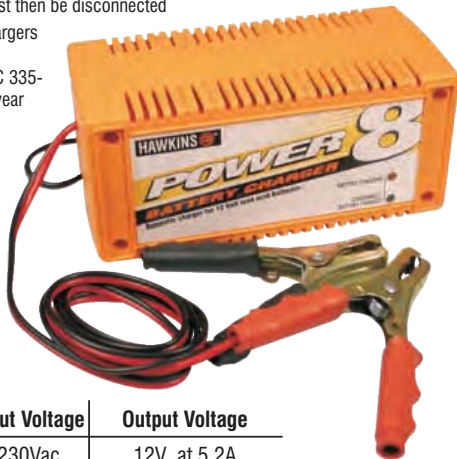

Code	Input Voltage	Output Voltage
HAW6-6G	230Vac	12V at 5,2A



BATTERY CHARGER - POWER 10

- Manual taper charger
- Current can be switched between 5A and 10A
- Transformer is protected by an automatic reset thermal circuit breaker
- Input to the charger is protected by a mains fuse in the socket
- Resettable circuit breaker will trip if the charge current higher than 10A flows into the battery
- Charger is not automatic and must be periodically monitored
- The Power Series of chargers were designed in compliance with IEC 335-2-2 and has a two year limited warranty against defects in materials and workmanship
- **NOT RECOMMENDED FOR SEALED BATTERIES**

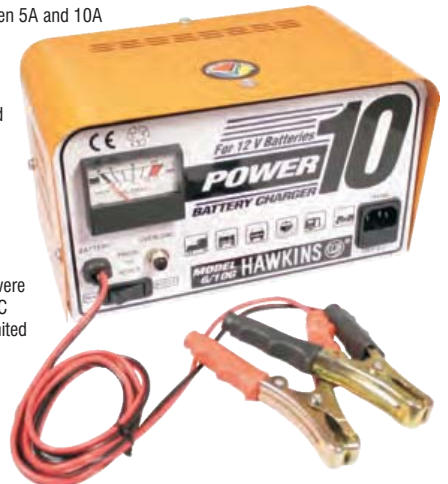

Code	Input Voltage	Output Voltage
HAW6-10G	230Vac	12V at 6,4A



BATTERY CHARGER - SMART 15

- Is a 2 stage automatic charger
- Switch on the front panel selects either 5A or 10A charge current
- Electronic control card regulates the output voltage thereby preventing overcharging
- Potential free clamps prevents sparking when connecting to the battery
- Charger requires a minimum of 10V to be present on the battery before it will start charging
- Battery leads are protected by a battery fuse located under the charger
- Charger can be left connected to the battery unattended for extended periods
- Input to the charger is protected by a replaceable mains fuse
- The Smart Series of chargers were designed in compliance with IEC 335-2-2 and has a two year limited warranty against defects in materials and workmanship
- **RECOMMENDED FOR SEALED & VENTED BATTERIES**



Code	Input Voltage	Output Voltage
HAW15A	230Vac	12V at 10A



BATTERY CHARGER - PRO 15

- Is a multi battery charger capable of charging 6v, 12v or 24v batteries
- Voltage selection switch allows the user to set the appropriate voltage
- Current selection switch varies the charge current up to 10a
- Fuse on the front panel will blow if the pro 15 is connected incorrectly to the battery
- Resettable circuit breaker will trip if a charge current higher than 10a is selected
- Input to the charger is protected by a mains fuse in the socket
- **NOT RECOMMENDED FOR SEALED BATTERIES**



Code	Input Voltage	Output Voltage
HAW12-10G	230Vac	6V / 12V / 24V at 10A

- Is a multi battery charger capable of charging 6V, 12V or 24V batteries
- Voltage selection switch allows the user to set the appropriate voltage
- Current selection switch varies the charge current up to 20A
- Fuse on the front panel will blow if the PRO 30 is connected incorrectly to the battery
- Resettable circuit breaker will trip if a charge current higher than 20A is selected
- Input to the charger is protected by an internal mains fuse
- **NOT RECOMMENDED FOR SEALED BATTERIES**



Code	Input Voltage	Output Voltage
HAW12-20G	230Vac	6V / 12V / 24V at 20A

- Is a bench, type 18A 12V / 24V manual battery charger or 200A engine starter
- Voltage selection is made by connecting the charging cable to either the 12V or 24V stud
- Current can be varied by switches on the front panel
- Transformer is protected by an automatic reset thermal circuit breaker
- The Pro Series of chargers were designed in compliance with IEC 335-2-2 and has a two year limited warranty against defects in materials and workmanship
- **NOT RECOMMENDED FOR SEALED BATTERIES**



Code	Input Voltage	Output Voltage
HAWPRO224	230Vac	12V 18,5A or 24V 19A

- Is a dual multi battery charger capable of charging 12V, 24V or 36V batteries
- Charger can charge up to 6 x 12V batteries at a time
- Charger has 2 identical banks that can each charge 3 x 12V batteries
- Voltage selection switch allows the user to set the appropriate voltage per bank
- Current selection switch varies the charge current up to 10A per bank
- Fuse on the front panel will blow if the PRO 615 is connected incorrectly to the battery
- Resettable circuit breaker will trip if a charge current higher than 10A is selected
- Input to the charger is protected by an internal mains fuse
- **NOT RECOMMENDED FOR SEALED BATTERIES**



Code	Input Voltage	Output Voltage
HAW36-10G	230Vac	12V / 24V / 36V at 10A

- Is a trolley type 30A 12V / 24V manual battery charger or 300A engine starter
- Voltage selection is made by connecting the charging cable to either the 12V or 24V stud on the top panel
- Current can be varied by a rotary switch on the front panel
- Transformer is protected by an automatic reset thermal circuit breaker
- Manual reset circuit breaker protects against incorrect polarity or too high a charging current
- The Pro Series of chargers were designed in compliance with IEC 335-2-2 and has a two year limited warranty against defects in materials and workmanship
- **NOT RECOMMENDED FOR SEALED BATTERIES**

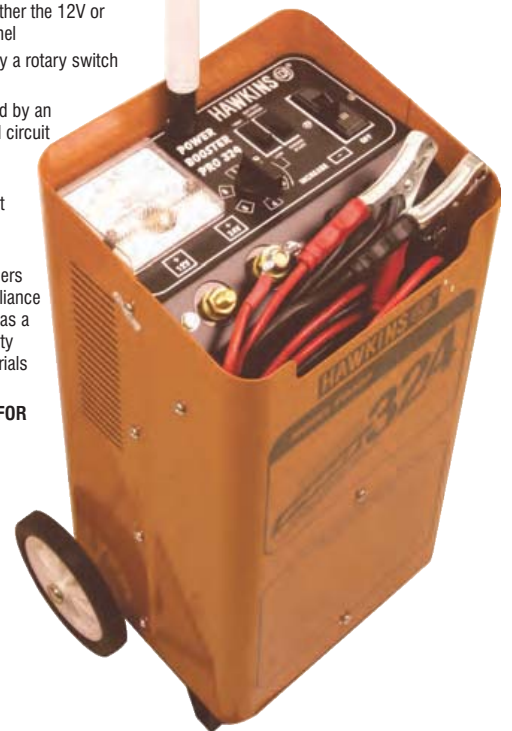

Code	Input Voltage	Output Voltage
HAWPB300	230Vac	12V 37A or 24V 44A



BATTERY CHARGER - PRO 524

- Is a trolley, type 60A 12V / 24V manual battery charger or 500A engine starter
- Voltage selection is made by connecting the charging cable to either the 12V or 24V stud
- Current can be varied by a rotary switch on the front panel
- Unit incorporates a reverse polarity light to indicate incorrect connection to the battery
- Has an engine start button that has to be pressed when the unit is used as a jump starter
- Built in timer is handy for charging at high currents for short periods.
- Transformer is protected by an automatic reset thermal circuit breaker
- The Pro Series of chargers were designed in compliance with IEC 335-2-2 and has a two year limited warranty against defects in materials and workmanship
- **NOT RECOMMENDED FOR SEALED BATTERIES**



Code	Input Voltage	Output Voltage
HAW6-60GX	230Vac	12V 68A OR 24V 91A



BATTERY LOAD TESTER - BLT 600

- Is an adjustable carbon pile load tester that can provide a discharge current of up to 600A for 15 seconds
- Able to test either 6V or 12V batteries.
- Has a voltmeter and an ammeter
- Capable of testing batteries up to 200Ah capacity



Code	Input Voltage	Discharge Current
HAW0400	6Vdc/12Vdc	Up to 600A



DC INVERTER

- Takes 12V dc and converts that to a modified sine-wave 230Vac
- Unit is ideal for using on TVs, DVD players, power tools, CFL lights etc
- Ideal for taking into the bush and charging your camera batteries, powering laptops as well as providing lighting from your car battery
- Unit is reverse polarity as well as short circuit protected
- Unit has a universal mains socket that accepts a wide variety of plugs
- Minimum recommended battery size: 12V 105Ah



Code	Input Voltage	Output Voltage
HAW1200W	12V	230Vac



BOOSTER CABLES

- Heavy duty crocodile clips with comfortable soft plastic handles
- Cables are securely welded and crimped to the clips
- Convenient zip bag allows the cables to be stowed away neatly



Code	Size
HON0550	200A
HON0552	400A



STRAP WRENCH - HEAVY DUTY - RT12/273B

- Lever handle made from hardened heavy gauge steel
- Heavy duty bonded strap for extra strength
- Comfortable vinyl grip
- Ideal for use on automotive oil filters and pipes



Code	Size
RIC6030	225mm



STRAP WRENCH - 12005

- For oil filters
- Up to 140mm diameter



Code	Length
STW76500001	450mm

RIDGID STRAP WRENCHES

- Designed for clamping polished surfaces
- Strong, woven nylon strap gives tight grip
- Polyurethane coated strap prevents scratching
- Replacement straps available



Code	Ref.	Size
RID31335	No 1	425mm
RID31345	No 2	760mm



OIL FILTER - STRAP WRENCH 36

- Chrome Vanadium steel 31CrV3
- Chrome plated
- Strong wide strap
- Light duty



Code	Size
GED632732	220mm

Strap Only Code	Ref.
GED532738	E36/1



FILTER WRENCH

- Adjustable to fit all size filters
- Automatic action hardened steel clamp has serrated inner surface for secure grip
- High impact plastic handle
- Rust proof baked enamel finish



Code	Size
RIC5720	225mm



OIL FILTER REMOVER STRAP TYPE 038600

- For removing oil, fuel and water filters, gripping hubs and brake drums, removing exhausts
- Strong steel shank and tough polyester strap
- Compact design gives high leverage in restricted areas
- Spares: 038605 Spare Strap



Code	Capacity Ø	Drive
SYK038600	0-300mm	13/16" Hex & 1/2" Sq Drive



OIL FILTER REMOVER HEAVY DUTY CHAIN TYPE 038900

- For removing large oil, fuel and water filters on commercial vehicles, plant machinery and industrial engines
- Robust construction with mild steel shank and heavy duty leaf link chain



Code	Capacity Ø	Drive
SYK038900	150mm	1" Hex & 1/2" Sq Drive



OIL FILTER WRENCH - 12007/2

- Adjustable for diameters 80-110mm
- Hardened anti-slip cams ensures safety in use
- With lever handle

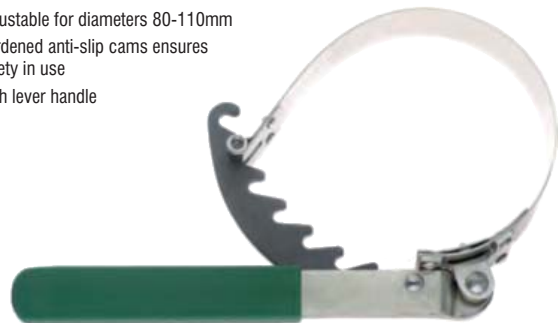

Code	Size
STW76521002	240mm

OIL FILTER REMOVER WRENCH 038100

- A spider-type oil filter wrench designed for use where access is limited
- The geared legs automatically tighten as the load increases, securely gripping the filter for safe, easy removal



Code	Capacity Ø	Drive
SYK038100	62-93mm	19mm Hex & 3/8" Sq Drive



BATTERY TERMINAL CLEANER

- 4-way terminal / post cleaner
- Positive and negative sized scrapers
- Female terminal reamer with 8 sharpened flutes



Code	Size
RIC0440	4 Way



TELESCOPIC SWIVEL MIRROR

- 50mmØ round mirror
- Extends from 280 - 440mm
- Chrome plated telescopic handle
- Ideal inspection tool for difficult-to-see places
- Cushion grip handle



Code	Size Ø
HON3800	50mm



MIRROR INSPECTION TOOL - TELESCOPIC

- Round mirror 50mm diameter
- Overall length 275mm extendable to 412mm
- Chrome plated telescopic handle with insulated vinyl grip
- A useful tool for all types of inspection work where visibility is impaired or obstructed



Code	Length
RIC2220	412mm



TELESCOPIC MIRROR - 12920N

- Non twisting oval-section telescopic rod
- Rectangular mirror



Code	Size	Length
STW77401001	65 x 43mm	310-750mm



TELESCOPIC MIRROR - 12921N

- Non twisting oval-section telescopic rod
- Round mirror



Code	Size Ø	Length
STW77401030	30mm	265 - 705mm
STW77401060	60mm	295 - 735mm



MAGNETIC PICKUP TOOL

- Plated flexible shaft with powerful magnet
- Picks up bolts, screws, washers etc. in difficult-to-reach places



Code	Length
HON7025	600mm



MAGNETIC PICKUP TOOL - 12600

- Flexible shaft for accurate access
- Fitted with magnets for lifting
- Loss of adhesion above 80°C

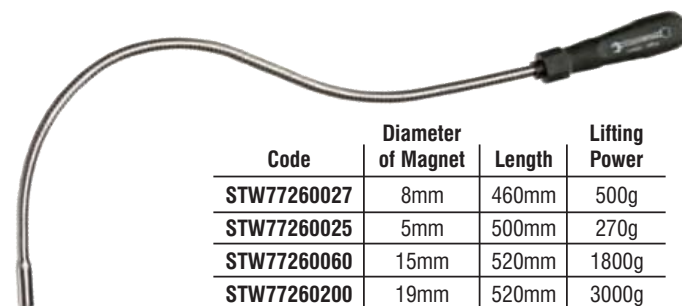

Code	Diameter of Magnet	Length	Lifting Power
STW77260027	8mm	460mm	500g
STW77260025	5mm	500mm	270g
STW77260060	15mm	520mm	1800g
STW77260200	19mm	520mm	3000g

TELESCOPIC MAGNETIC PICK-UP 670006

- Magnetic telescopic extension
- Fitted with pocket clip

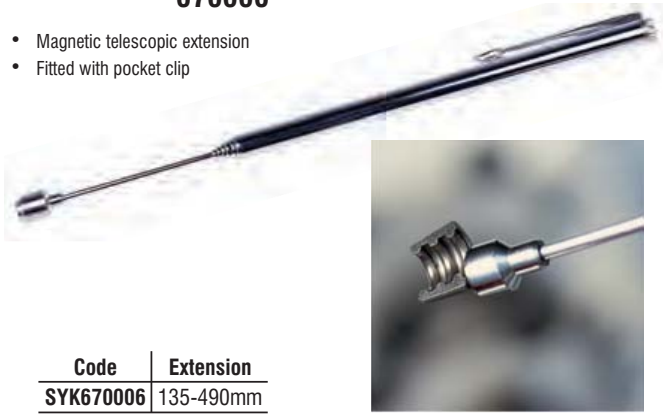

Code	Extension
SYK670006	135-490mm

PICKUP CLAW TOOL

- Plated flexible shaft with 4 finger claw grip
- Push plunger with return spring
- Picks up bolts, screws, washers etc. in difficult-to-reach places



Code	Length
HON7024	600mm

PICKUP CLAW TOOL

- Plated, flexible shaft with 5 finger claw grip
- Push plunger
- Picks up bolts, screws, washers etc. in difficult to reach places
- Perfect for starting threaded screws in inaccessible spots
- An all-round tool for mechanics, around the home and workshops

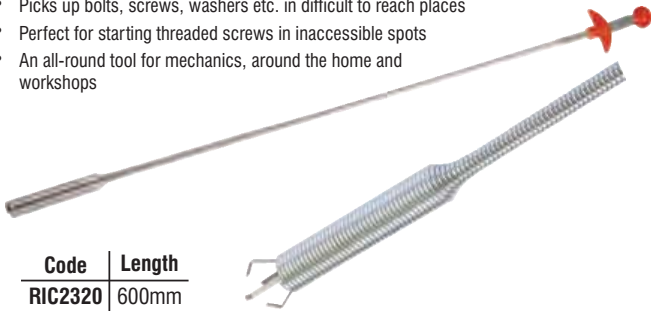

Code	Length
RIC2320	600mm

JET REAMER - 16 PCE 11085

- Jet reamers in case with holder



Code	Measuring Range
STW74310001	0.33 – 2.0mm

FLARING TOOL KIT - DOUBLE

- Professional set includes:
- Heavy duty tube cutter for 3 - 30mm tube
- Drop forged steel yoke, hard chrome plated
- Hardened steel flaring bar with sizes 4, 6, 8, 10, 12, 14 and 16mm
- 5 x double-flare adaptors, chemical black finished
- Packed in PVC carry case



Code	Size
RIC1340	4-16mm

FLARING TOOL - DOUBLE LAP - 027000

- Produces convex and double lap flares to SAE and DIN standards on automotive brake and clutch pipes
- 'Dial a size' punch turret with OP1 and OP2 punches positioned next to each other
- Lever cam operated for quick and easy flaring
- Automatic punch extraction
- Screw clamp for accurate die alignment



Code	Pipe Sizes
SYK027000	SAE Single and Double: 3/16", 1/4", 5/16", 3/8", 4.75mm DIN Single: 4.75mm

FLARING TOOL KIT - 027008

- Produces convex and double lap flares to SAE and DIN standards on automotive brake and clutch pipes
- 'Dial a size' punch turret with OP1 and OP2 punches positioned next to each other
- Lever cam operated for quick and easy flaring
- Automatic punch extraction
- Screw clamp for accurate die alignment



Code	Pipe Sizes
SYK027008	SAE Single and Double: 3/16", 1/4", 5/16", 3/8", 4.75mm, 6mm, 8mm, 10mm, 12mm DIN Single: 4.75mm

FLARING TOOL - FLAREMASTER 2 - 027250

- The ultimate power flaring tool
- Designed for use on the car
- Revolutionary new design
- Creates single or double SAE or DIN flares in an instant
- Unique hydraulic power pack makes tool extremely powerful
- Piping can be replaced in place
- Full or part sections can be spliced in as required



Code	Size
SYK027250	SAE Single and Double: 3/16", 4.75mm DIN Single: 4.75mm

FLARING TOOL - DOUBLE 165

- Will form accurate flares on seamless drawn and double walled (BUNDY) tubing
- Clamped in a vise the tool is instantly ready for use
- Flaring and pressure cones are quickly changed
- Shape of flaring cones enables single cone flaring on tubes of 0.7 or 1.0mm wall thickness
- Held horizontally by 25mm wide clamping blocks
- Important when endless tubing is used
- Distant pin controls length of tube required for flaring

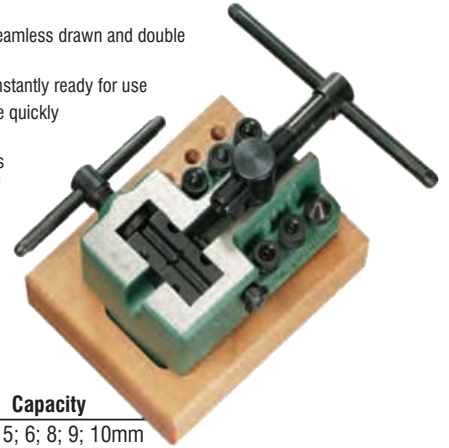

Code	Capacity
STW63030000	4.75; 5; 6; 8; 9; 10mm

RIDGID FLARING TOOL - RATCHET TYPE - 458R

- Provides smooth, uniform flares with minimum effort
- A ratchet feed screw handle turns easily
- Hardened steel flaring cone, eccentrically mounted in needle bearings, produces rolling action for even metal flow, giving uniform flare walls without galling
- For aluminium, soft copper, steel, stainless steel, hard copper and brass
- 45° SAE Flares



Code	Sizes
RID83037	1/8", 3/16", 1/4", 5/16", 3/8", 1/2", 5/8", 3/4"

BRAKE SPRING PLIERS

- For rivetted brake linings/shoes
- Chrome vanadium, bright nickel plated



Code	Size	Ref.
STW76413001	210mm	10613
STW76413002	330mm	10613

CYLINDERS HONE 2 & 3 LEG

- 2 leg hone for brake cylinders 16 - 19mm diameter
- 3 leg hone for 21 - 69mm diameter
- Collar prevents stone breakage
- Sleeve makes insertion into cylinder easy and protects stones when not in use
- For use with variable speed drill
- Spare stone sets are available - please quote code RIC1060 (2 leg) & RIC1065 (3 leg)



Code	Size
RIC1050	2 Leg
RIC1055	3 Leg

CYLINDER HONE - 028100

- Suitable for use on large bore engine cylinders on cars and commercial vehicles
- Can be used with electric or air powered drills
- Flexible drive shaft for easy alignment
- Complete with medium grade 220 grit stones



Code	Size
SYK028100	50-180mm

CYLINDER HONE 4-IN-1 SET - 028000

- Complete honing and deglazing kit for cylinder bores from 13-89mm
- Suitable for use on brake and clutch cylinders, motorcycles and small bore car engine cylinders
- Can be used with electric or air powered drills
- Flexible drive shaft for easy alignment
- Complete with medium grade 220 grit stones



Code	Size
SYK028000	13-89mm

CYLINDER HONE, SPARE STONE SETS

- Suitable for 028000 & 028101 cylinder hones
- Contents: 3 x 19mm, 3 x 29mm, 3 x 50mm stones
- 9 x replacement spring clips
- Suitable for cylinder hone 028100
- Contents: 3 x 100mm stones
- 3 x Replacement cotter pin



028000 STONE SETS		
Code	Grit	Ref.
SYK028001	400 Fine	028001
SYK028002	220 Med.	028002

028100 STONE SETS		
Code	Grit	Ref.
SYK028101	400 Grit	028101
SYK028102	220 Grit	028102
SYK028103	100 Grit	028103



WHEEL BALANCING PLIER - 10599/2

- With cutter
- Trims and cuts lead weights
- Chrome vanadium
- Plated



Code	Size
STW76294003	245mm



TYRE LEVERS 38

- CHROME VANADIUM steel 31CrV3
- Drop forged
- Chrome plated



Code	Length
GED633267	400mm
GED633283	500mm



TYRE LEVER

- Used in the motor industry for lifting tyres off wheel rims
- Manufactured from the finest quality spring steel and have forged working ends which are ground to provide maximum working efficiency

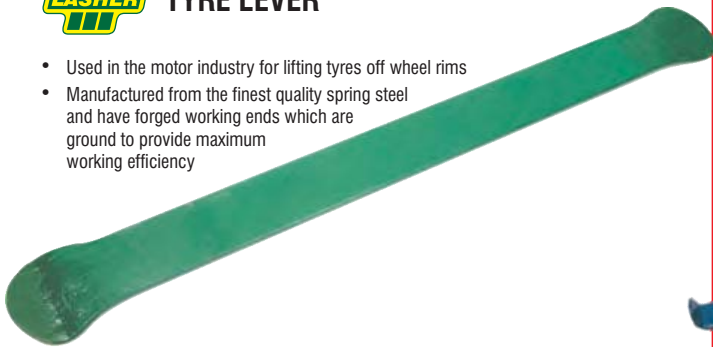

Code	Size
LAS3285	550mm



TYRE LEVER 39

- CHROME VANADIUM steel 31CrV3
- Drop forged
- Blue epoxy powder coated



Code	Ref	Length
GED633305	39	610mm



PISTON RING PLIERS

- Special pliers for mounting & removing piston rings
- Bright nickle plated



Code	Piston Ring Ø	Length	Ref.
STW74152001	50-100mm	200mm	11069-1
STW74152002	80-120mm	240mm	11069-2



STUD REMOVER

- Capacity 1/4" (6mm) - 3/4" (19mm)
- Use with 1/2" square drive wrench handle
- Knurled chrome-molybdenum steel wheel gear is heat treated to extreme hardness and accurately machined to assure a firm grip
- Heavy duty, hardened alloy steel housing is triple chrome plated



Code	Size
RIC4040	6-19mm



NUT SPLITTERS

- For splitting nuts of quality range up to 8.8(55tpsi)
- Galvanised



Code	Size	Ref
STW71250011	10-18mm	12615/1
STW71250012	19-27mm	12615/2



BALL JOINT SEPARATOR - 080700

- With a strong, large body and strengthened fork and lever
- The large force screw allows greater force to be applied to the ball joint
- For use on heavy commercial vehicles



Code	Size
SYK080700	Throat Depth : 50mm Throat Width : 36mm Jaw Opening : 70mm

VALVE GRINDERS

- For grinding and lapping valves
- Wooden handle
- Rubber suction cup for firm, positive grip
- Large, single ended
- Commercial vehicles, agricultural and industrial engines



Code	Cup Ø	Length	Ref.
SYK660904	19mm	224mm	660904
SYK660903	22mm	224mm	660903
SYK660902	32mm	224mm	660902

STANDARD GARAGE CREEPER

- Six wheels with bearing castors
- Handy tool compartment
- Cushion Headrest
- Lightweight
- Comfortable ergonomically shaped body
- Spare wheels are available - please quote code HON0846



Code	Package Size LWH (mm)	Gross Weight (kg)
HON0847	940 x 430 x 80	2.8

GARAGE CREEPER - ADJUSTABLE HEADREST

- Six wheels with bearing castors
- Cushioned for comfort
- Lightweight and strong
- Rigid tubular steel frame for extra strength
- Spare wheels are available - please quote code HON0849



Code	Package Size LWH (mm)	Gross Weight (kg)
HON0848	1170x460x130	8.4

bosal CREEPERS

- Sturdy tubular steel frame for strength and lightness
- Contoured, flexible polypropylene support straps are comfortable and easy to keep clean
- Rugged castor wheels with built-in roller bearings for superior strength and manoeuvrability



Code	No of Wheels	Height (mm)	Width (mm)	Length (mm)	Gross Weight (kg)
BOS0005	4	100	430	1300	3.5
BOS0006	6	100	430	1300	4.2

ENGINE STAND

- For auto mechanics, engine rebuilders and hobbyists
- Heavy gauge tubular steel construction with reinforced stress areas for added strength
- Head unit swivels 360° and has a multi-position locking mechanism
- Adjustable arms are slotted for quick and easy mounting to engine block
- Long handle with rubber grips helps the operator rotate the head to the desired position for easy installation of parts



Code	Capacity (kg)	Length (mm)	Width (mm)	Height (mm)	Gross Weight (kg)
MOB30750	341	810	730	775	22.0

TOWBAR - STEEL EXTENDABLE

- Solid steel construction
- Preformed steel hooks on each end for safe secure towing
- Compact and easy to stow away
- Complete with red PVC warning flag

Packed individually



Code	Capacity (Tons)	Max Length (mm)	Gross Weight (kg)
MOB0996	2	1750	2.8



BODY REPAIR KITS - 4 & 10 TON

- Ideal for collision damage repair
- Perfect fit attachments use quick-connect technology for effortless assembly
- Sets are portable for easy usage in the workshop or on the road
- Custom fitted, rugged blow moulded carry case
- Designed for applications of pushing, spreading and pressing of the vehicle body panels as well as various component parts and assemblies
- A variety of attachments are included

Part No.	Capacity (Tons)	Ram Minimum Height (mm)	Maximum Height (mm)	Ram Stroke	Pump Work Pressure (bar)	Gross Weight (kg)
MOB8045	4	330	450	120	700	20.0
MOB8002	10	460	610	150	700	40.0

